

RCP5W-RA10C

Dust and splash-proof specifications
 Coupled Motor
 Body width 110 mm
 24V Stepper motor

Model Specification Items

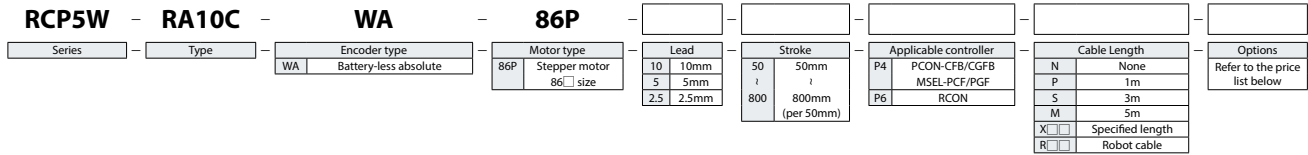

CE RoHS

Horizontal Vertical Side Ceiling

Radial Load OK

- POINT Selection Notes**
- The actuator specifications display the payload's maximum value, but it varies depending on the acceleration and speed. Please refer to "Table of Payload by Speed/ Acceleration" for more details.
 - The radial cylinder has a built-in guide. For the allowable load mass, refer to the "Rod tip allowable load mass" graph.
 - The cable joint connector is not splash-proof, so install it where it will not be exposed to water.
 - Special attention needs to be paid to the mounting orientation. Please refer to P1-361 for details.
 - Please refer to P1-431 for push-motion operation.
 - When connecting to the RCON, a conversion unit or conversion cable is will be required. Please refer to P7-41 for details.

Stroke			
Stroke (mm)		Stroke (mm)	
50	<input type="radio"/>	450	<input type="radio"/>
100	<input type="radio"/>	500	<input type="radio"/>
150	<input type="radio"/>	550	<input type="radio"/>
200	<input type="radio"/>	600	<input type="radio"/>
250	<input type="radio"/>	650	<input type="radio"/>
300	<input type="radio"/>	700	<input type="radio"/>
350	<input type="radio"/>	750	<input type="radio"/>
400	<input type="radio"/>	800	<input type="radio"/>

Option		
Name		Option code
Brake		B
Flange		FL
Non-motor end specification		NM

Cable Length	
Type	Cable code
Standard type	P(1m)
	S(3m)
	M(5m)
Specified length	X06(6m) ~ X10(10m)
	X11(11m) ~ X15(15m)
	X16(16m) ~ X18(18m)
Robot cable	R01(1m) ~ R03(3m)
	R04(4m) ~ R05(5m)
	R06(6m) ~ R10(10m)
	R11(11m) ~ R15(15m)
	R16(16m) ~ R18(18m)

Main Specifications

Item		Description				
Lead	Ball screw lead (mm)	10	5	2.5		
	Payload (Note1)	Maximum payload (energy-saving mode disabled) (kg)	64	120	240	
Horizontal	Speed/acceleration/deceleration	Max. speed (mm / s)	200	100	50	
		Min. speed (mm / s)	13	7	4	
		Rated acceleration/deceleration (G)	0.04	0.02	0.01	
		Max. acceleration/deceleration (G)	0.04	0.02	0.01	
Vertical	Payload	Maximum payload (energy-saving mode) (kg)	64	80	120	
		Speed/acceleration/deceleration	Max. speed (mm / s)	130	100	50
			Min. speed (mm / s)	13	7	4
			Rated acceleration/deceleration (G)	0.04	0.02	0.01
Push force	Max. thrust force when pushing (N)	1500	3000	6000		
		Max. speed when pushing (mm/s)	10	10	10	
Brake	Brake specification		Non-excitation actuating solenoid brake			
	Brake force (kgf)	64	80	120		
Stroke	Min. stroke (mm)	50	50	50		
	Max. stroke (mm)	800	800	800		
	Stroke pitch (mm)	50	50	50		

Item	Description	
Driving system	Ball screw φ20mm (Lead 2.5/10) Rolled C10 Ball screw φ16mm (Lead 5) Rolled C10	
Positioning repeatability	±0.02mm	
Lost motion	0.1mm or less	
Main material	Base	Aluminum, white anodized
	Front bracket	Aluminum, white anodized
	Seal	Urethane rubber (U)
	Actuator cable	Vinyl chloride (PVC)
Rod	40mm Material: Aluminum Hard anodized	
Rod non-rotation accuracy (Note 2)	0 degrees	
Ambient operation temperature/humidity	0~40°C, 85%RH or less (Non-condensing)	
Degree of protection	IP65	
Vibration & shock resistance	4.9m/s ² 100Hz or less	
Overseas standards	CE marking, RoHS	
Motor type	Stepper motor	
Encoder type	Battery-less absolute	
Number of encoder pulses	800 pulse/rev	

(Note 2) This indicates the rod displacement angle with no load.

(Note 1) When a radial load is received with an external guide.

Table of Payload by Speed/Acceleration

The unit of the payload is kg.

Lead 10

Orientation	Horizontal
Speed (mm / s)	Acceleration (G)
0	64
80	64
140	64
160	64
180	30
190	16
200	12

Orientation	Vertical
Speed (mm / s)	Acceleration (G)
0	64
27	64
30	55
36	46
42	40
60	28
84	16
96	12
112	8
121	6
130	4.5

Lead 5

Orientation	Horizontal
Speed (mm / s)	Acceleration (G)
0	120
66	120
100	120

Orientation	Vertical
Speed (mm / s)	Acceleration (G)
0	80
16	80
20	72
32	52
36	44
44	32
46	29.5
48	28
52	23
54	21.5
56	20
61	16
72	10
80	7
84	5.5
100	2

Lead 2.5

Orientation	Horizontal
Speed (mm / s)	Acceleration (G)
0	240
33.5	240
50	240

Orientation	Vertical
Speed (mm / s)	Acceleration (G)
0	120
16	120
24	80
28	60
30	52
40	24
44	16
50	8

Stroke and maximum speed

Lead (mm)	50 (mm)	100 (mm)	150~400 (mm)	450 (mm)	500 (mm)	550 (mm)	600 (mm)	650 (mm)	700 (mm)	750 (mm)	800 (mm)	
10	117	167	200			<130>			180	160	140	120
5	83	100		90	80	70	60	55	50	45	45	
2.5	50			45	40	35	30					

(Unit is mm / s)

(Note) < > indicates vertical use.

Correlation of push force and current limit value

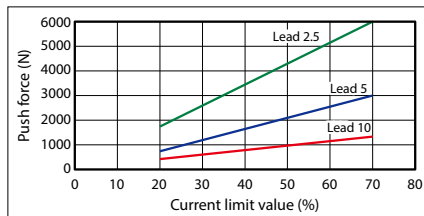

Rod Deflection (Reference Values)

The graph below shows the measurements of how much a horizontally mounted rod would deflect when a load is applied to the end of the rod, excluding deflection due to the rod's own weight.

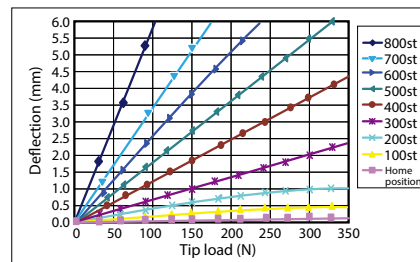

Warnings for push operation

Due to the buckling load of the ball screw, the push force of some models is limited. Refer to the table below. Just put a (N) above the top right corner of the graph.

Lead	Stroke					
	550mm or less	600mm or less	650mm or less	700mm or less	750mm or less	800mm or less
10	As shown in the push force graph					
5	As shown in the graph	2900	2500	2200	2000	1800
2.5	As shown in the push force graph					

See the table below as a guide for the upper limit of the number of pushing operations when operating at the maximum push force and traveling a distance of 1mm.

Lead (Type)	2.5	5	10
Number of push cycles	1.4 million times	25 million times	157.6 million times

Note: The maximum number of push cycle varies depending on operating conditions such as impact shock and vibration. The above number assumes that there is no impact shock or vibration.

Rod tip allowable load mass

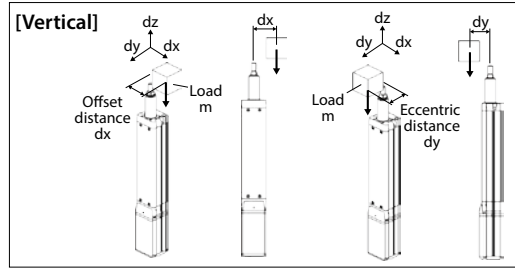
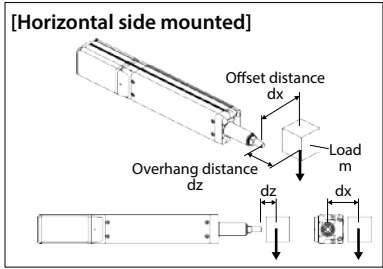
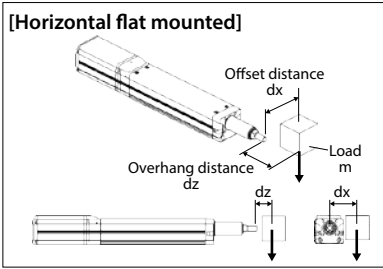

Horizontal

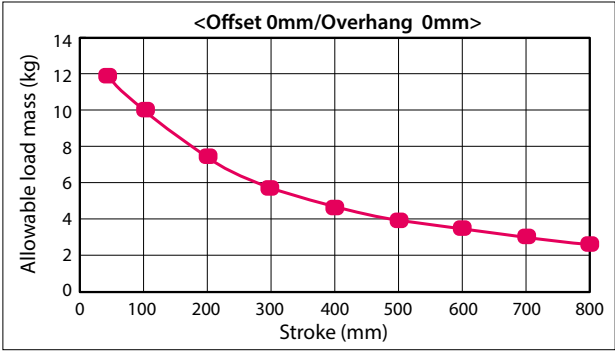

Allowable load calculation conditions:
 Load mass corresponding to a product service life of 5,000km,
 considering moments generated by acceleration/deceleration.
 (Acceleration 0.04G, speed 250mm/s)

Vertical

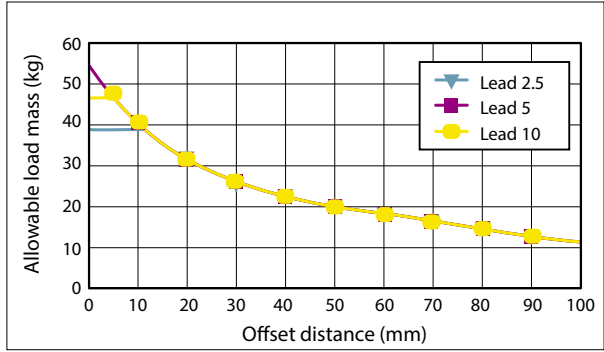

Load mass corresponding to a product service life of 5,000km,
 considering moments generated by acceleration/deceleration.
 (Acceleration 0.04G, speed 167mm/s)

Correlation between the vertical payload and life expectancy

Since the RCP5W-RA10C has a larger maximum thrust than other types, its life expectancy varies significantly depending on the payload and push force applied when the actuator is mounted vertically. When selecting a type using the "Table of Payload by Speed/ Acceleration" or "Correlation of push force and current limit value", please check the life expectancy in the below graphs.

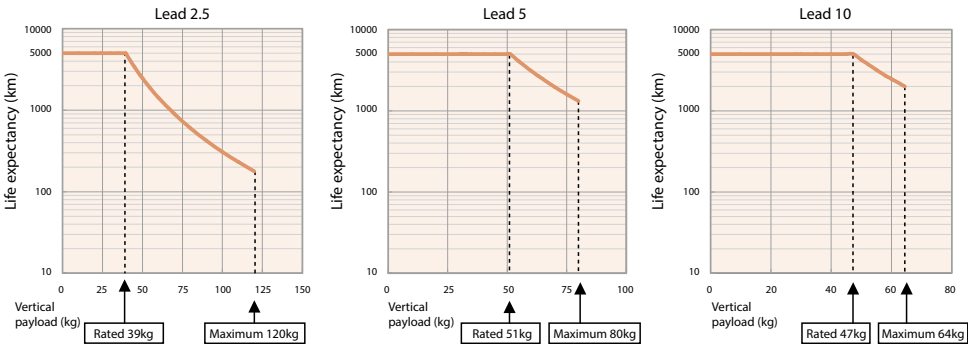

Note) The rated value is the maximum payload for a running life of 5,000 km. The maximum value represents the maximum payload that can be applied. Please note that the life expectancy will be shortened, as shown in the above graphs, when operating beyond the rated values.

Dimensions

(Note) Connect the motor / encoder cable to the pigtail cable connector.
 (Note) When returning to the home position, the rod will move to M.E., so be careful of interference from surrounding objects.
 (Note) The direction of width across flats varies depending on the product. Those flats cannot be used for reference plane.
 (Note) When mounting the actuator using the front housing and flange, make sure that no external force is applied to the actuator.
 (Note) The orientation of the width across flats is indeterminate.

CAD drawings can be downloaded from our website.
www.intelligentactuator.com

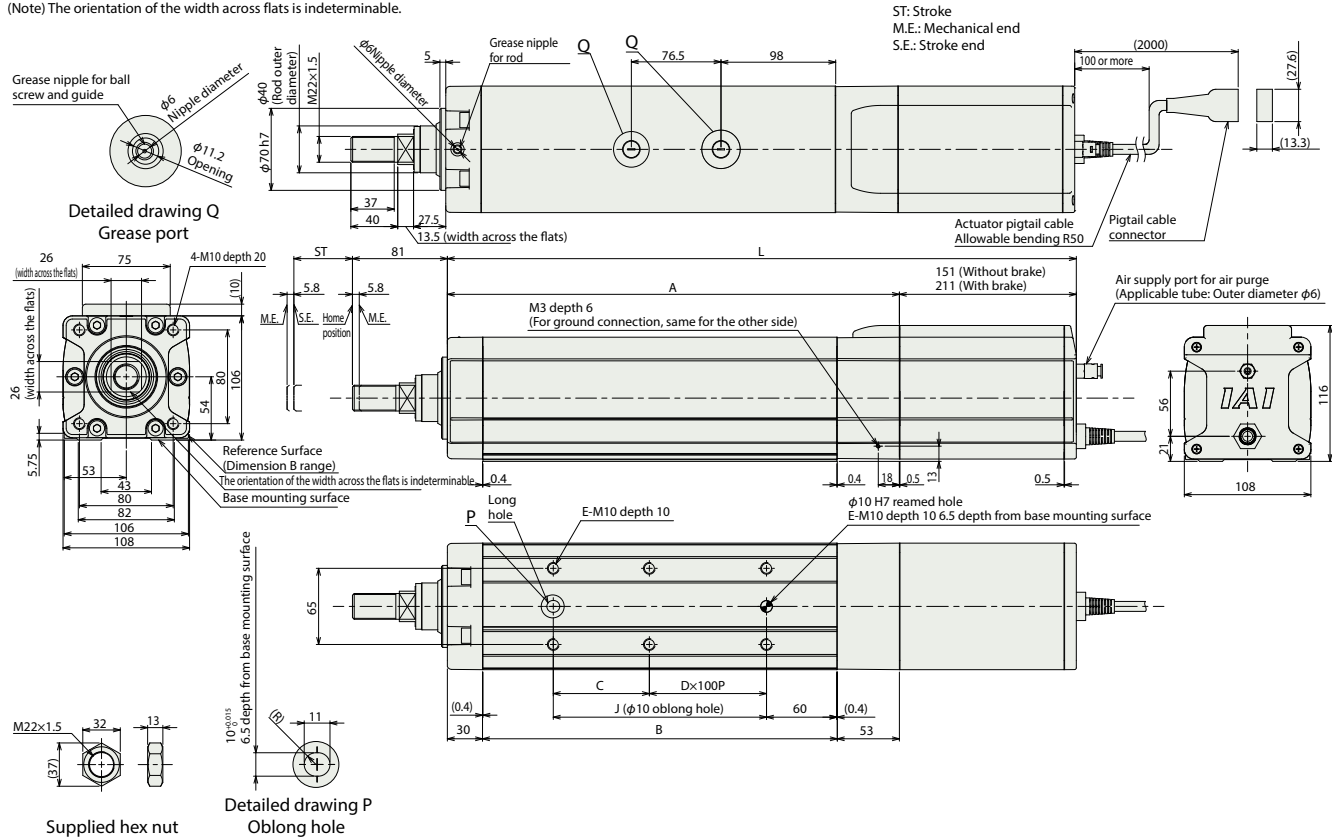

Dimensions by stroke

Stroke	50	100	150	200	250	300	350	400	450	500	550	600	650	700	750	800	
L	Without brake	486.8	536.8	586.8	636.8	686.8	736.8	786.8	836.8	886.8	936.8	986.8	1036.8	1086.8	1136.8	1186.8	1236.8
	With brake	546.8	596.8	646.8	696.8	746.8	796.8	846.8	896.8	946.8	996.8	1046.8	1096.8	1146.8	1196.8	1246.8	1296.8
A	335.8	385.8	435.8	485.8	535.8	585.8	635.8	685.8	735.8	785.8	835.8	885.8	935.8	985.8	1035.8	1085.8	
B	252.8	302.8	352.8	402.8	452.8	502.8	552.8	602.8	652.8	702.8	752.8	802.8	852.8	902.8	952.8	1002.8	
C	132	82	132	82	132	82	132	82	132	82	132	82	132	82	132	82	
D	0	1	1	2	2	3	3	4	4	5	5	6	6	7	7	8	
E	4	6	6	8	8	10	10	12	12	14	14	16	16	18	18	20	
J	132	182	232	282	332	382	432	482	532	582	632	682	732	782	832	882	
Allowable static load on rod tip (N)	316.9	268.4	232.6	205.1	183.4	165.7	151.0	138.6	128.1	119.0	111.0	103.9	97.7	92.1	87.0	82.5	
Allowable dynamic load on rod tip (5000km life expectancy) (N)	Load offset 0mm	119.1	99.1	84.7	73.8	65.3	58.5	52.8	48.1	44.0	40.5	37.5	34.8	32.4	30.2	28.3	26.5
	Load offset 100mm	100.7	85.9	74.9	66.3	59.3	53.6	48.8	44.7	41.2	38.1	35.4	32.9	30.8	28.8	27.0	25.4
Allowable static torque on rod tip (N·m)	31.8	27.0	23.4	20.7	18.5	16.8	15.3	14.1	13.1	12.2	11.4	10.7	10.1	9.6	9.1	8.6	
Allowable dynamic torque on rod tip (N·m)	10.1	8.6	7.5	6.6	5.9	5.4	4.9	4.5	4.1	3.8	3.5	3.3	3.1	2.9	2.7	2.5	

Mass by stroke

Stroke	50	100	150	200	250	300	350	400	450	500	550	600	650	700	750	800	
Mass (kg)	Without brake	12.5	13.2	13.9	14.6	15.3	16	16.7	17.4	18.1	18.8	19.5	20.2	20.9	21.6	22.3	23
	With brake	14.1	14.8	15.5	16.2	16.9	17.6	18.3	19	19.7	20.4	21.1	21.8	22.5	23.2	23.9	24.6

Main material

① Frame	Aluminum extruded material (A6N01SS-T5 equivalent) 5 White alumite treatment
② Base	Aluminum extruded material (A6N01SS-T5 equivalent) 5 White alumite treatment
③ Front bracket	Aluminum die casting
④ Rear bracket	Aluminum die casting
⑤ Rear cover	Aluminum die casting
⑥ Motor cover	Aluminum extruded material (A6063SS-T5 equivalent) 5 White alumite treatment
⑦ Rod	Aluminum drawn tube (equivalent to A6063TD-T83) buffed finish + hard anodized
⑧ Actuator cable	Vinyl chloride (PVC)
⑨ Intake and exhaust port	Polyphenylene sulfide (PPS)

Applicable controllers

The actuators on this page can be operated using the following controllers. Please select the type that suits your application.



Name	External view	Max. number of connectable axes	Power supply voltage	Control method													Maximum number of positioning points	
				Positioner	Pulse-train	Program	Network *select											
				DV	CC	CIE	PR	CN	ML	ML3	EC	EP	PRT	SSN	ECM			
MSEL-PCF/PGF		4	Single phase 100~230VAC	—	—	●	●	—	●	—	—	—	●	●	●	—	—	30000
PCON-CFB/CGFB (86P motor compatible type)		1	DC24V	●	●	—	●	●	●	●	●	●	●	●	—	—	—	512 (Network specification 768)
RCON		16		—	—	—	—	●	●	●	—	—	—	●	●	—	—	128

(Note) For network abbreviation symbols such as DV and CC, please refer to page 7-15.
 (Note) MSEL-PCF/PGF 3rd and 4th axes cannot be connected. Please contact IAI for more details.

Actuator Installation Orientation

Depending on the actuator model, there are Installation orientations that cannot be used or require caution. Please check the details of the Installation orientations of each model on the table below before using.

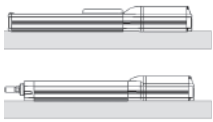
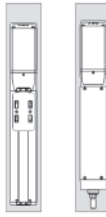
○: Can be installed △: Required daily checking ×: Can not install

			Installation Orientation			
						
Classification	Series	Type	Horizontal flat plane installation	Vertical installation (*1)	Sideways installation	Ceiling installation
Slider Type	EC	S/SAH	○	○	△ (*2)	△ (*2)
	RCP6(S)	SA/WSA	○	○	△ (*2)	△ (*2)
	RCP5	BA	○	×	△ (*2) (*3) (Only for strokes less than 1000mm)	△ (*2) (*3) (Only for strokes less than 1000mm)
	RCP4	SA	○	○	△ (*2)	△ (*2)
	RCP3	SA2	○	×	×	×
		SA3	○	○	○	△ (*2)
		SA4/SA5/SA6	○	○	△ (*2)	△ (*2)
	RCA	SA	○	○	△ (*2)	△ (*2)
	RCS4	SA/WSA	○	○	△ (*2)	△ (*2)
	RCS3/ RCS3P	SA	○	○	○ (*4)	○ (*4)
		SS	○	○	△ (*2)	△ (*2)
	RCS2	CT8	○	×	×	○
		SA4	○	○	○	△ (*2)
	ISB/ISPB	SA5/SA6SA7	○	○	△ (*2)	△ (*2)
		SXM/SXL/MXM/ MXL/LXM/LXL	○	○	○ (*6)	○ (*7)
	SSPA	MXMX/LXMX/ LXUWX	○	×	×	△ (*7) (Only for strokes less than 1300mm)
		S/M/L	○	○	○ (*6)	○ (*7)
	ISA	WXM	○	○	○ (*6)	△ (*7) (Only for strokes less than 1300mm)
		WXMX	○	×	×	△ (*7) (Only for strokes less than 1300mm)
	ISDB/ISPDB	S/M/L	○	○	△ (*2)	△ (*2)
MX/LX		○	×	×	×	
NSA	MXMS/MXMM/ LXMS/LXMM/ WXMS/WXMM	○	×	×	×	
	NS	SXMX/SXMM/ MXMS/MXMM/ LXMS/LXMM	○	×	×	○ (*8) (Only for strokes less than 1600mm)
SZMS/SZMM/ MZMS/MZMM/ LZMS/LZMM		×	○	×	×	
MXMXS/LXMXS		○	×	×	×	
IF	SA/MA	○	×	×	○ (*7)	
Rod Type	EC	R/RR/RRAH/ RP4/GS4/GD4	○	○	○	○
	RCP6(S)	RA/RRA/WRA	○	○	○	○
	RCP5	RA	○	○	○	○
	RCP4	RA (*10)	○	○	○	○
	RCP3	RA2	○	○	○	○
	RCP2	RA/SR	○	○	○	○
	RCD	RA	○	○	○	○
	RCA2	RN/RP/GS/GD	○	○	○	○
		SD	○	○ (*11)	○	○
	RCA	RA	○	○	○	○
	RCS4	RA/RRA/WRA	○	○	○	○
	RCS3	RA15/RA20 (without load cell)	○	○	○	○
	RCS2	RA/RN/RP/GS/ GD/SR/RG	○	○	○	○
		SD (*12)	○	○	○ (*11)	○

○: Can be installed △: Required daily checking ✕: Can not install

Classification	Series	Type	Horizontal flat plane installation	Vertical installation (*1)	Sideways installation	Ceiling installation
Table Type	EC	TC4/TW4	○	○	○	○
	RCP6(S)	TA (*13)	○	○	○	○
	RCP3	TA	○	○	○	○
	RCA2	TCA/TWA/TFA	○	○	○	○
	RCS4	TA	○	○	○	○
	RCS3/RCS3P	CTZ5C	○	○	✕	✕
	RCS2	TCA/TWA/TFA	○	○	○	○
Linear servo	LSA	S6/S8/S10	○	✕	○	✕
		N10/N15	○	✕	✕	✕
		W21	○	✕	✕	✕
	LSAS	N10/N15	○	✕	✕	✕
Servo press	RCS3	RA4/RA6/RA7/R8/R10	○	○	○	✕
	RCS2	RA15/RA20	○	○	✕	✕
Gripper	RCP6	GRST6/GRST7	○	○	△ (*2)	△ (*2)
		GR7T	○	○	○	○
	RCP4	GR	○	○	○	○
	RCP2	GR	○	○	○	○
Solenoid gripper	GRS	GRSNA	○	○	○	○
		SEG/MEG SIG/MIG	○	○	○	○
Rotary chuck	RCP6	RTCKSPE/RTCKMPE	○	○	○	○
		RTCKSPI/RTCKMPI	○	○	○	○
		RTCKSRE/RTCKMRE	○	○	○	○
		RTCKSRI/RTCKMRI	○	○	○	○
Rotary	RCP6	RTFML	○	○	○	○
	RCP2	RT	○	○	○	○
	RCS2	RTC	○	○	○	✕
Direct drive motor	DDA	LT/LH	○	○	○	○
Rotation	RS		○	○	○	○
Stopper cylinder	RCP4	ST	✕	○ (Only rod up)	✕	✕
Vertical/Rotation	ZR	S/M	✕	○ (Refer to 1-364)	✕	✕
Cleanroom	RCP6CR(S)	SA/WSA	○	○	△ (*2) (*9)	△ (*2) (*9)
	RCP4CR	SA	○	○	△ (*2) (*9)	△ (*2) (*9)
	RCP2CR	GR	○	○	○	○
		RT	○	○	○	○
	RCACR	SA	○	○	△ (*2) (*9)	△ (*2) (*9)
	RCA2CR	RN/RP/GS/GD	○	○	○	○
		SD	○	○ (*11)	○	○
	RCS4CR	SA/WSA	○	○	△ (*2) (*9)	△ (*2) (*9)
	RCS3CR	SA/SS	○	○	△ (*2) (*9)	△ (*2) (*9)
	RCS2CR	SA/SS	○	○	△ (*2) (*9)	△ (*2) (*9)
		RN/RP/GS/GD	○	○	○	○
	DDACR	SD (*12)	○	○ (*11)	○	○
		LT/LH	○	○	○	○
	ISDBCR/ISPDBCR	S/M/L	○	○	△ (*2) (Only for strokes less than 400mm)	△ (*2) (Only for strokes less than 400mm)
		MX/LX	○	○	✕	✕
SSPDACR	S/M/L	○	—	—	—	
ISDACR/ISPDACR	W	○	○	△ (*2) (Only for strokes less than 400mm)	△ (*2) (Only for strokes less than 400mm)	
	WX	○	✕	✕	✕	
Dust-proof and splash-proof	EC	R6W/R7W	○	○	○	○
	RCP6W	RA/RRA/WRA	○	○	○	○
	RCP5W	RA	○	○	○	○
	RCP4W	SA	○	✕	○ (*5)	○ (*5)
	RCP2W	GR	○	○	○	○
		RT	○	○	○	○
	RCA2W	RN/RP/GS/GD	○	○	○	○
		SD	○	○ (*11)	○	○
	RCS2W	RN/RP/GS/GD	○	○	○	○
		SD (*12)	○	○ (*11)	○	○
ISWA/ISPWA	S/M/L	○	✕	✕	✕	
DDW	LH	○	○	○	✕	

Pressing Operation

As with pneumatic cylinders, push motion is a function to keep holding rods and sliders pressed against workpiece etc. Some models may not be used depending on the model of the actuator, so please make sure the following usage instructions and notes.

[Compatible with push motion]

Motor type	Series	Model	Availability	Notes
Pulse motor	EC/RCP6/ RCP5/RCP4 RCP3/RCP2	Slider type	○	Push motion is possible. (See note 1 below)
		Rod type	◎	It is suitable for pushing operation. (See note 2 below)
	RCP2/RCP5	Belt type	×	Since the pushing force of the belt is not stable, it can not be pushed.
Servo motor (DC24V)	RCA2/RCA	All model	△	See notes 2 below
Servo motor (AC100/200V)	RCS4	All model	△	See notes 2 below
	RCS3	RA4R/RA6R/RA7R/ RA8R/RA10R/ RA15R/RA20R	◎	It is suitable for pushing operation.
		Other models	△	See notes 2 below
	RCS2	RA13R	◎	It is suitable for pushing operation.
		Other models	△	See notes 2 below

[Notes]

- When pushing with the slider type, it is necessary to consider the allowable dynamic moment of the guide. For details, please refer to the correlation diagram page of push force and current limit value of each slider type. (P1-433)
- RCP6 / RCP5 / RCP4 / RCP3 / RCP2 series are recommended for pushing applications. The RCP6 / RCP5 / RCP4 / RCP3 / RCP2 series are excellent in stopping stability at the time of pushing, and when compared with the RCA2 / RCA / RCS2 series of equivalent product cross section, a large pushing force can be obtained. Please contact our company for pressing on the RCA 2 / RCA / RCS 2 series.

[Adjustment of pressing force]

- The pushing force (pushing force) can be adjusted by changing the current limit value of the controller.
- Check the pushing force of each model referring to the "Correlation diagram of pushing force and current limit value" on P1-433 to P1-447 and select the model that suits the condition.

* Please confirm the following caution concerning "Correlation diagram of pressing force and current limit value".

(Note)

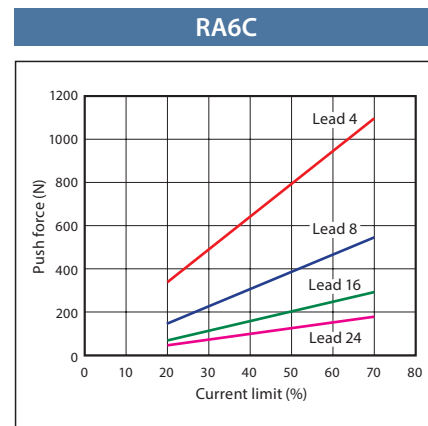

<Correlation diagram of pressing force and current limit value>



Caution

The correlation diagram between the pushing force and the current limit value shows the lower limit of the pushing force at each current limit value. Even if the current limit value is the same, depending on the aircraft, due to the individual differences of the motor and the variation of the mechanical efficiency, the pushing force lower limit value may be about 40% higher.

Except for the force control function, pushing force is not controlled by thrusting operation but by feedback control of current value. As a result, individual differences and variations may occur in the pressing force due to variations in the holding torque of the motor, individual differences such as ball screws and bearings, and changes in lubrication conditions. It is assumed that the holding torque of the motor itself has variations of about 30% due to the difference of the lot.

When accurate pushing force is required, please use actuator and controller which can use force control function. (See the right page)

Network Compatibility

Compatible with the majority of main field networks widely used over the world.
It is also highly compatible with FA devices such as PLCs and touch panels.

1 Compatible with main field networks

Direct connection is possible with main field networks such as DeviceNet or CC-Link, etc.

A position controller is available for an operation defined by movement specified with position number and direct coordinate value using the network.

(When defining coordinate values directly, there is no restriction for the number of positioning points.)



Compatible network and functions

As of December 2018

Controller series	Ellipsis	position controller									program controller							PLC built-in	
		PCON -CB	ACON -CB	SCON -CB	SCON -CAL	SCON-CB (servo press specification)	DCON -CB	MCON -C	MSCON	RCON	PSEL	ASEL	SSEL	TTA	MSEL	XSEL -P/Q	XSEL -RA/SA	MCON -LC	SCON -LC
Field network type	DeviceNet	DV	●	●	●	●	●	●	●	●	●	●	●	●	●	●	●	●	●
	CompoNet	CN	●	●	●	●	●	●	●	●	●	●	●	●	●	●	●	●	●
	EtherCAT	EC	●	●	●	●	●	●	●	●	●	●	●	●	●	●	●	●	●
	EtherCAT Motion	ECM	—	—	—	—	—	—	●	—	—	—	—	—	—	—	—	—	—
	EtherNet/IP	EP	●	●	●	●	●	●	●	●	●	●	●	●	●	●	●	●	●
	CC-Link	CC	●	●	●	●	●	●	●	●	●	●	●	●	●	●	●	●	●
	CC-Link IE Field CIE	CIE	●	●	●	—	●	●	●	—	●	—	—	—	—	—	—	—	—
	SSCNET III/H	SSN	—	—	—	—	—	—	●	—	—	—	—	—	—	—	—	—	—
	MECHATRO LINK I/II (*1)	ML	●	●	●	●	●	●	—	—	—	—	—	—	—	—	—	—	—
	MECHATRO LINK III (*1)	ML3	●	●	●	—	—	●	—	—	—	—	—	—	—	—	—	—	—
	PROFIBUS-DP	PR	●	●	●	●	●	●	●	●	●	●	●	●	●	●	●	●	●
	PROFINET IO	PRT	●	●	●	●	●	●	●	—	●	—	—	—	●	—	—	●	●
IA net	IA	—	—	—	—	—	—	—	—	—	—	—	●	●	●	—	—	—	
Number of positioning points (*2)		768					256			128	1500		20000	30000		20000	55000	256	768
Operating method	Position No. Movement by specifying positions	●	●	●	●	●	●	●	●	●	●	●	●	●	●	●	●	●	●
	Direct number Movement by specifying direct values	●	●	●	●	—	●	●	●	●	—	—	—	—	—	—	—	—	—
Reference page for controllers		P7-95	P7-121	P7-145	P7-185	P7-161	P7-121	P7-73	P7-199	P7-41	P7-211	P7-221	P7-231	P4-541	P7-211	P7- 5	P7-259	P7-73	P7-145

(*1) MECHATROLINK I/II is treated as an intelligent I/O, and supports only non-synchronous communication. MECHATROLINK III is compatible with the standard ServoProfile.

(*2) When it is operated by movement by specifying direct values, the number of positioning points is unlimited.

(*3) Able to cope with EtherNet (TCP/IP: message communication) when switching the parameters for EtherNet/IP.

(*4) It corresponds to Ethernet (TCP/IP: message communication) only for standard Ethernet.

RCON



Unit-linkage type position controller



Features

1 The RCON is recommended for actuators containing 2 axes or more.

A single Rcon driver unit of 22mm wide can accommodate actuators up to 2 axes, offering an ideal space-saving for the controller.

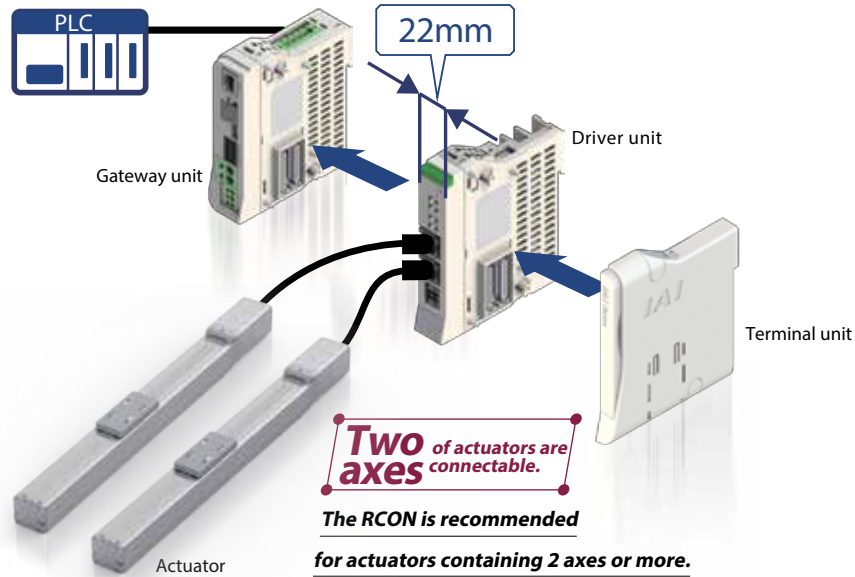

2 Space saving of the controller up to 85%*1 is possible. *1 Compared with IAI products.

Compared with the type that connects one driver unit and 1-axis actuator, the space for the controller can be reduced up to 85%.

PCON-CB X 16 units

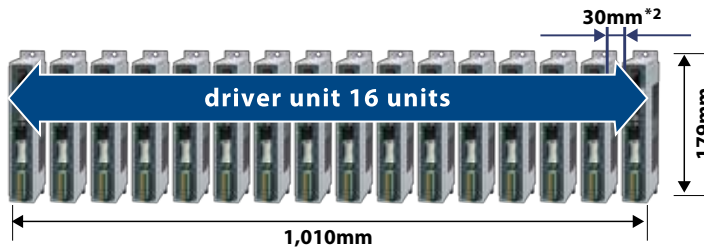

*2 The minimum distance required for the natural heat radiation for the controller.

RCON X 16 axes connectable specification

Space-saving 85%



3 No.1 compatibility in the industry. Compatible with 7 field networks.

Compatible with wide selection of field networks.



4 Preventive & Predictive Maintenance Function

The RCON is equipped with a preventive maintenance function for capacitors, and a predictive maintenance function for fan units and actuators.

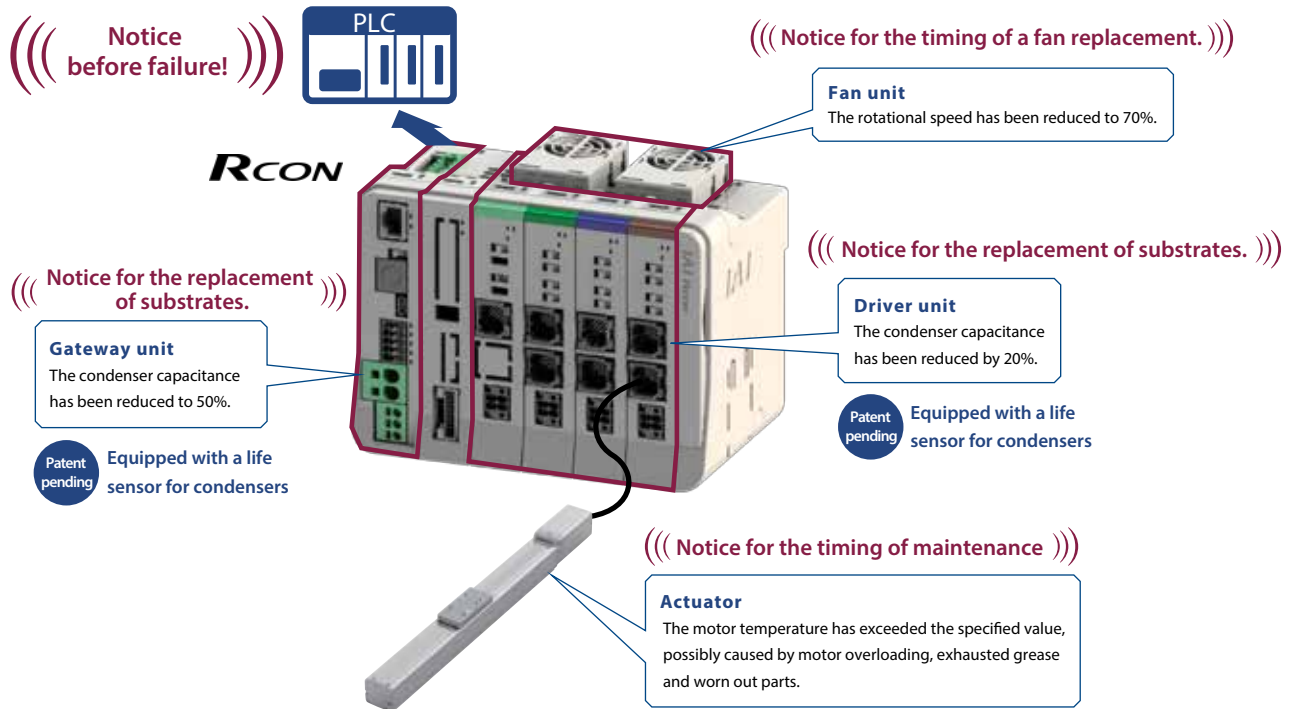

5 Operational at the controller operating temperature of 0 to 55°C.

When an optional fan unit is installed, the controller can be operable at 0 to 55°C without lowering the actuator operating duty.
(A fan unit is needed for every 2 driver units.)

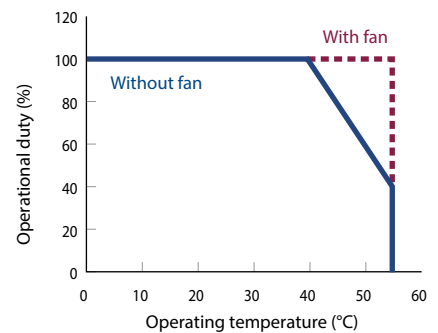
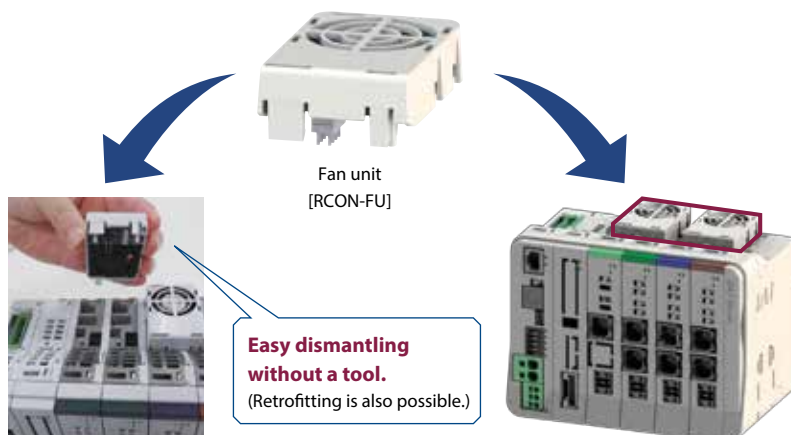

- EC
- RCP6S
- RCON**
- MCON -C/LC
- PCON -CB/CFB
- PCON
- ACON-CB
- DCON-CB
- ACON
- DCON
- SCON -CB
- SCON-CB (Servo press)
- SCON -LC
- SCON -CAL
- MSCON
- PSEL
- ASEL
- SSEL
- MSEL
- XSEL
- XSEL (SCARA)
- PSA-24
- TB-02
- TB-03

6 No.1 in the industry for the number of connectable actuators Connectable with 332 IAI actuator models.*

For RCP2/3/4/5/6, RCA/2, RCD, RCL series

Compatible with actuators that have not only battery-less absolute encoders but also actuators equipped with simple absolute encoders and incremental encoders.

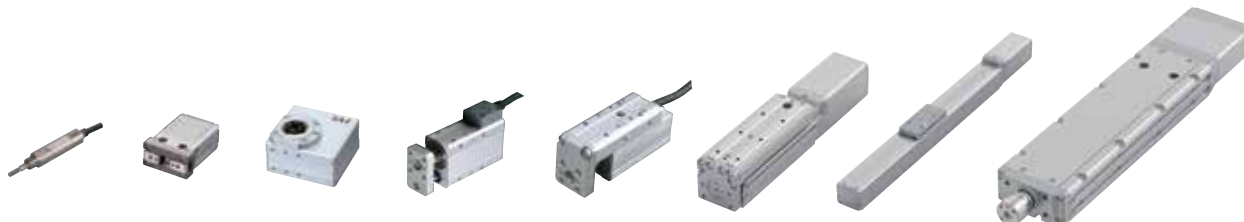

For RCS2/3/4, IS(D) B, SSPA, LSA, NS, DDA series

When selecting an optional RCON connection specification (-RC) of the SCON, an actuator equipped with a high-capacity motor can be operated by connecting to the RCON extension unit (RCON-EXT).

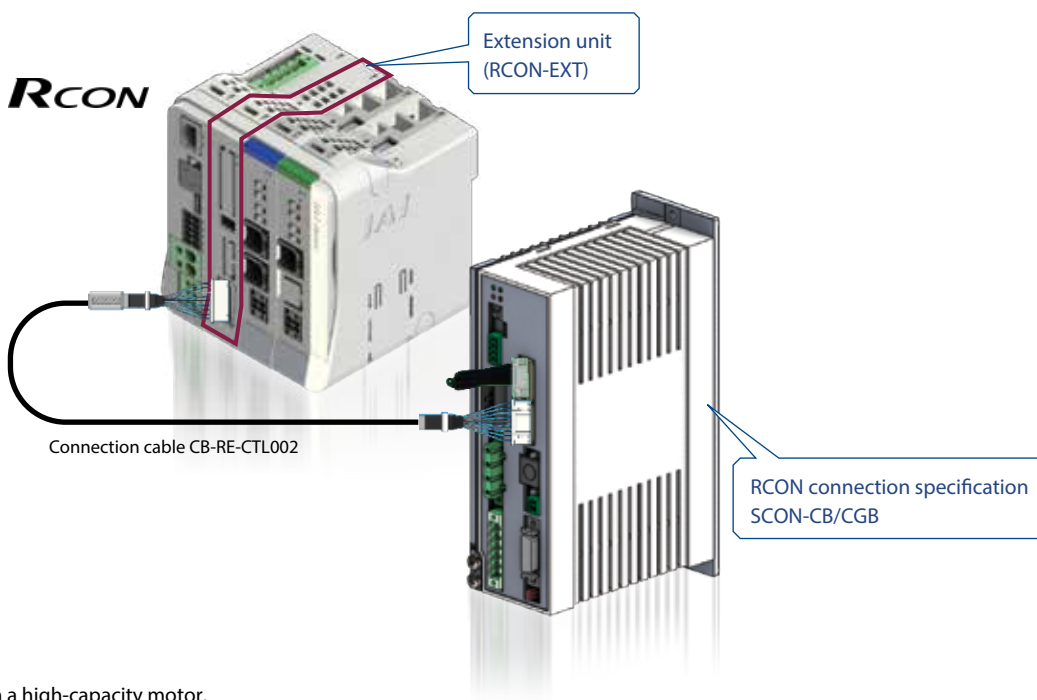

■ Actuator equipped with a high-capacity motor.

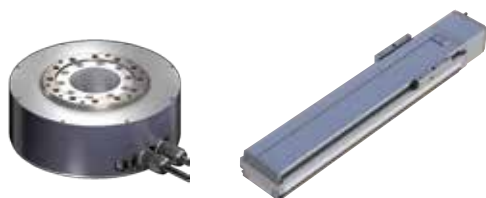

* IAI's General Catalog product series / types and models.
 Except for the servo press actuator models, LSA-W21H, EC series, SCARA robots, TTA, ZR units and wrist units.
 * As of December 2018.

Selection Procedure

Procedure 1 Selection of an Actuator

<Selection example>

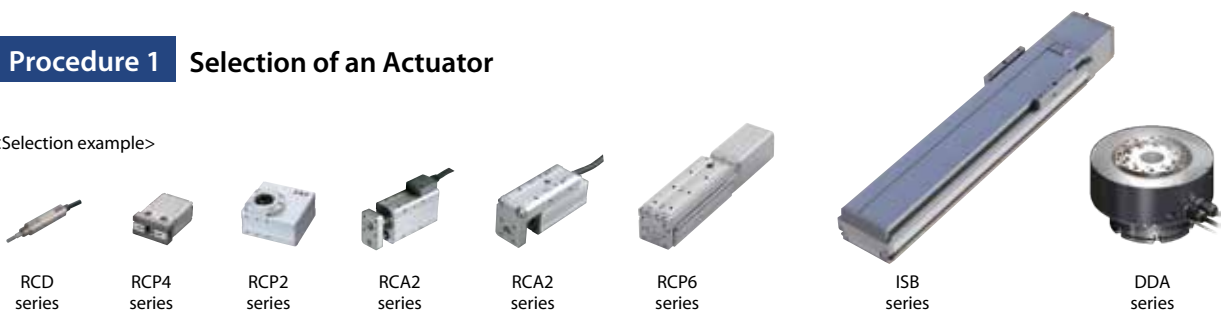

Classify the actuator series into 2 categories according to the table below.

Controller	Actuator
<p>RCON</p>	<p>RCP2/3/4/5/6, RCA/2, RCD, RCL series</p> <p><Selection example></p>
<p>SCON-CB</p>	<p>RCS2/3/4, IS(D)B, SSPA, LSA, NS, DDA series</p> <p><Selection example></p>

* Please note that servo press actuator models, LSA-W21H, EC series, SCARA robots, TTA, ZR units and wrist units cannot be connected.

Procedure 2 Selection of a Gateway Unit

Select a gateway unit model according to the network type.

Network type	Gateway unit model
DeviceNet	RCON-GW/GWG-DV
CC-Link	RCON-GW/GWG-CC
CC-Link IE Field	RCON-GW/GWG-CIE
PROFIBUS	RCON-GW/GWG-PR
EtherCAT	RCON-GW/GWG-EC
EtherNet/IP	RCON-GW/GWG-EP
PROFINET	RCON-GW/GWG-PRT

<Selection example>
 Select 1

Caution

Only one gateway unit can be connected to one system. If more than 2 units are used, divide it into 2.

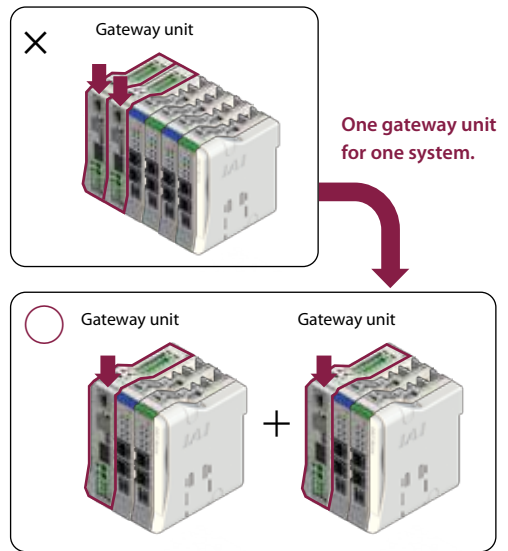







The number of connectable actuator axes is 16 for one gateway unit.

* GW --- Gateway unit of standard specification
 GWG --- Gateway unit of safety category compliant type

- EC
- RCP6S
- RCON
- MCON -C/LC
- PCON -CB/CFB
- PCON
- ACON-CB
- DCON-CB
- ACON DCON
- SCON -CB
- SCON-CB (Servo press)
- SCON -LC
- SCON -CAL
- MSCON
- PSEL
- ASEL
- SSEL
- MSEL
- XSEL
- XSEL (SCARA)
- PSA-24
- TB-02
- TB-03

Procedure 3 Selection of a Driver Unit

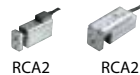
Select a suitable driver unit model and the required number according to the actuator series and motor type to be connected to the RCON.

Actuator		RCON driver unit			<Example of selection>	
Series	Motor type	External view	Number of connectable actuator axes	Model	Classification	Number of necessary units
RCP2 RCP3 RCP4 RCP5 RCP6	20P, 28P 35P, 42P 56P	Stepper motor 	2-axis specification	RCON-PC-2		1 unit
			1-axis specification	RCON-PC-1		1 unit
	High-thrust motor 56SP, 60P 86P	1-axis specification	RCON-PCF-1		—	
RCA RCA2 RCL	2 5 10 20, 20S 30	AC servo motor 	2-axis specification	RCON-AC-2		1 unit
			1-axis specification	RCON-AC-1		—
RCD	3D	DC brushless motor 	2-axis specification	RCON-DC-2		—
			1-axis specification	RCON-DC-1		1 unit

Select! 2

Select! 2

Select! 2

Select! 2

Procedure 4 Selection of a Simple Absolute Unit

When there are actuators of simple absolute specification, select the simple absolute units (RCON-ABU-A/P) in the same number as the actuator axes.

* Connect to the RCON controller using the cable (CB-ADPC-MPA005).
The cable is supplied with the sample absolute unit.
(Note) The operating ambient temperature of the simple absolute unit is 0 to 40°C.

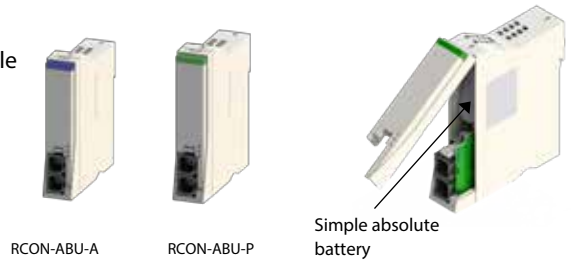

<Example of selection>

This example shows a selection of 2 axes of RCA2 series actuators as simple absolute specification.

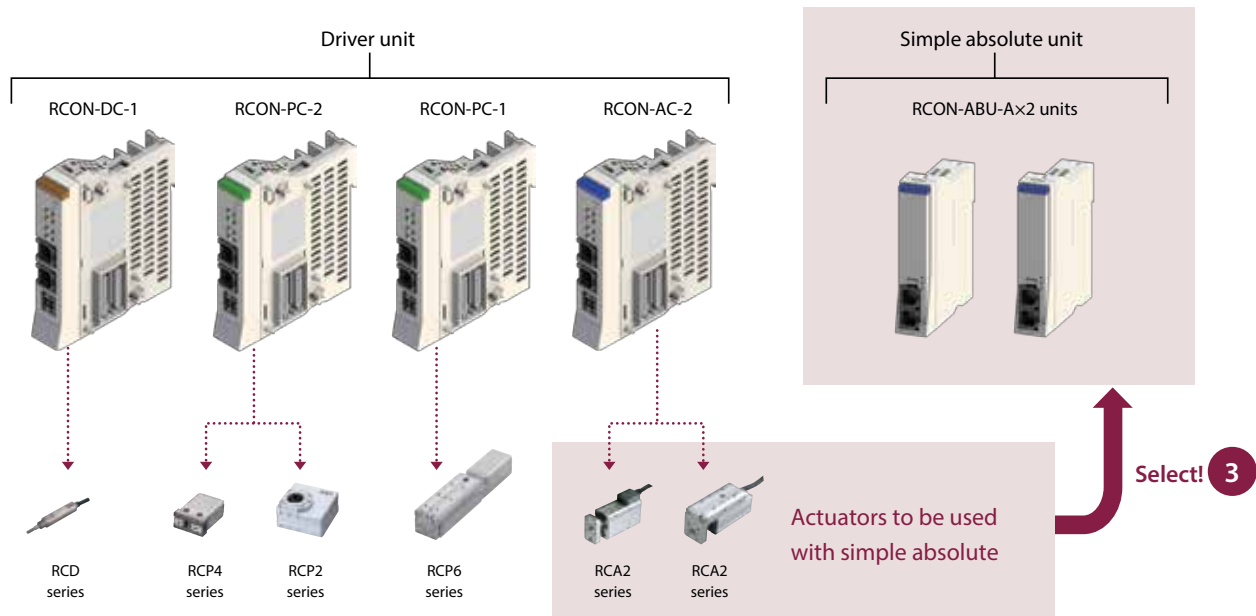

Procedure 5 Selection of an Extension Unit

When there is an actuator to be connected to the SCON-CB, select (1) to (3) as shown below.

(1) Extension unit (Model: RCON-EXT)

<Selection example>

An extension unit is definitely needed when connecting the SCON-CB and RCON.



× 1 unit ← Select! 4

(2) RCON connection specification SCON-CB

<Selection example>

I/O type
Model: SCON- * - * - * - RC - *

Necessary to purchase in the same number* as actuator axes connected to SCON.



Specify RCON connection specification

× 2 units ← Select! 5

(* Max. 16-axes)

(3) Connection cable between extension unit and SCON-CB.

A cable (CB-ER-CTL002) is supplied with the cable SCON-CB for connection with RCON.

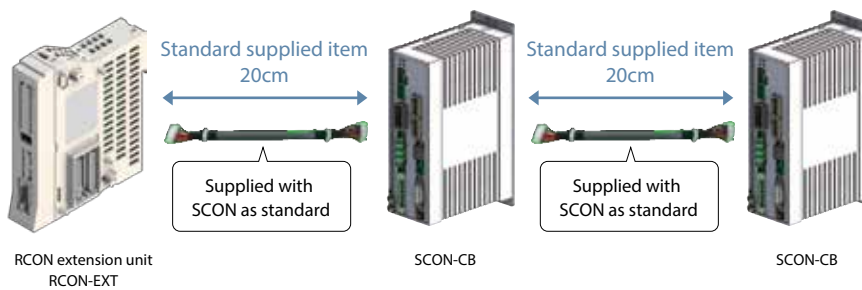

Necessary to purchase only when the length of 20 cm is too short.

Model: CB-RE-CTL□□□□
See 7-72



× Required number

- EC
- RCP6S
- RCON**
- MCON -C/LC
- PCON -CB/CFB
- PCON
- ACON-CB
- DCON-CB
- ACON DCON
- SCON -CB
- SCON-CB (Servo press)
- SCON -LC
- SCON -CAL
- MSCON
- PSEL
- ASEL
- SSEL
- MSEL
- XSEL
- XSEL (SCARA)
- PSA-24
- TB-02
- TB-03

Procedure 6 Calculation of Control Power (CP) of each unit

Confirm that the total control power capacity of the units selected so far is 9.0A or smaller.

Gateway unit



Control power capacity (CP)
9.0A or smaller

Confirmation method

Add up values according to the "Table of motor power capacities" shown below.

List of control power capacities

Item	Specification		
Power voltage	24VDC±10%		
Control power capacity (CP) (Per driver unit)	Gateway unit (including terminal unit)	0.8A	
	Driver unit (common in all types)	without Brake	0.2A
		with Brake (1-axis)	0.4A
		with Brake (2 axes)	0.6A
	Extension unit	0.1A	
	Simple absolute unit (common in all types)	0.2A	

<Selection example>

× 1 unit
× 3 units
× 1 unit
× 1 unit
× 1 unit
× 1 axes

<Selection example>

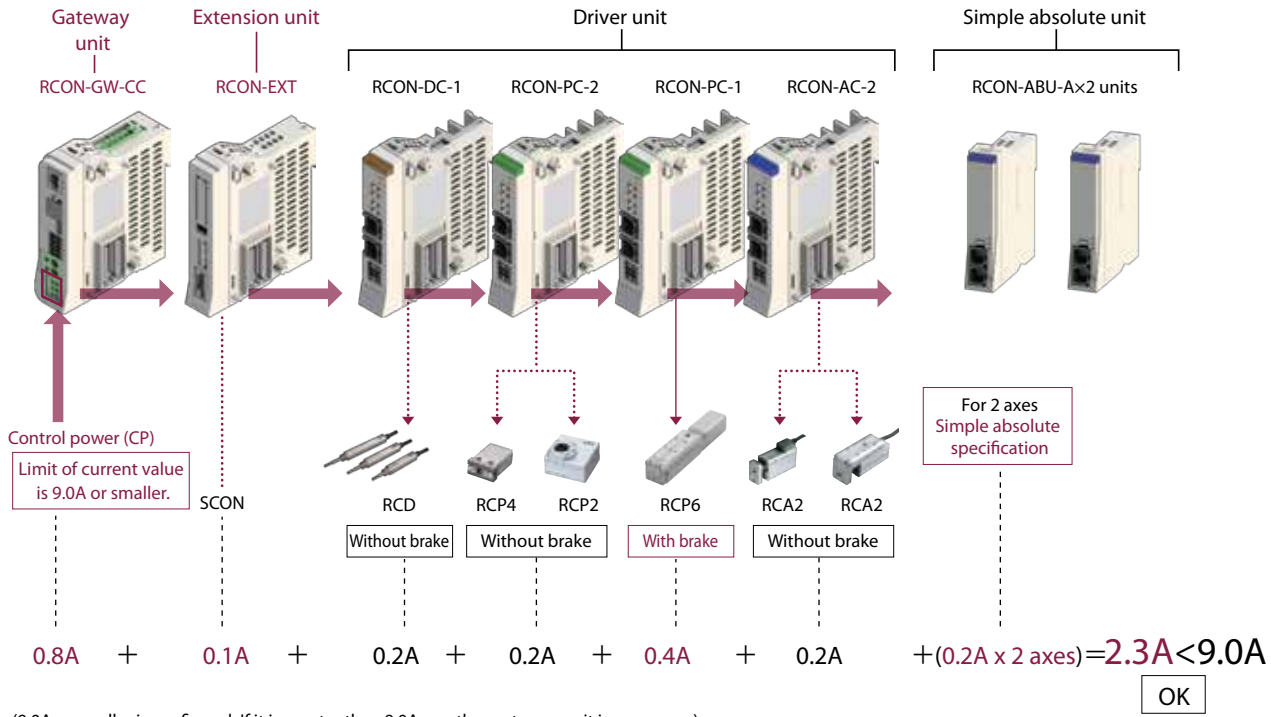

(9.0A or smaller is confirmed. If it is greater than 9.0A, another gateway unit is necessary.)

Procedure 7 Calculation of Motor Power Capacity (MP) of each unit motor

Confirm that the total motor power capacity of the driver units selected so far is 37.5A or smaller.

Gateway unit

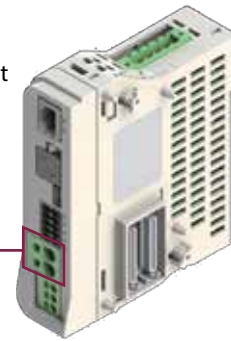

Motor power (MP)
37.5A or smaller

Confirmation method

Add up values according to the "Table of motor power capacities" shown below. Use the maximum current if shown in the table, otherwise use the rated current for calculation.

List of motor power capacity

Item	Actuator/driver unit			Rated current	Max. current		<Selection example>
	series	motor type			Energy-saving enabled		
Motor Power capacity (MP) (per actuator)	Stepper motor RCON-PC	RCP2	20P/20SP/28P	Without Power CON	0.8A	—	×1 axis
		RCP3	28P*		1.9A	—	
		RCP4 RCP5 RCP6	28P/35P/42P/ 42SP/56P	Without Power CON	1.9A	—	×2 axes
				With Power CON	2.3A	—	
	Stepper motor RCON-PCF	RCP2 RCP4 RCP5 RCP6	56SP/60P/ 86P	Without Power CON	5.7A	—	—
	AC servo motor RCON-AC	RCA RCA2	5W	Standard/ High acceleration/deceleration/ Energy saving	1.0A	—	3.3A
10W			1.3A		2.5A	4.4A	
20W			1.3A		2.5A	4.4A	
20W(20S)			1.7A		3.4A	5.1A	
RCL		2W 5W 10W	Standard/ High-acceleration/deceleration	0.8A	—	4.6A	
				1.0A	—	6.4A	
				1.3A	—	6.4A	
				—	—	—	
DC brushless motor RCON-DC	RCD	3W	Standard	0.7A	—	1.5A	×1 axis

* for RCP2-RA3 and RCP2-RGD3

<Selection example>
Gateway unit



Motor power (MP)
Current limit
37.5A or smaller

Driver unit

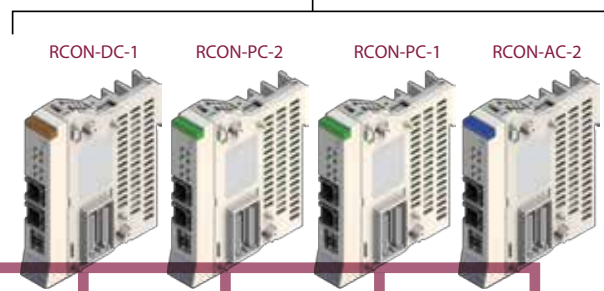

Actuator	Series	Motor type
	RCD	3W
	RCP4	28P
	RCP2	20P
	RCP6	35P
	RCA2	20W
	RCA2	20W

$$1.5A + 3.9A + 0.8A + 3.9A + 4.4A + 4.4A = 18.9A < 37.5A$$

(37.5A or smaller is confirmed. If it is greater than 37.5A, another gateway unit is necessary.)

OK

Controller

- EC
- RCP6S
- RCON
- MCON -C/LC
- PCON -CB/CFB
- PCON
- ACON-CB
- DCON-CB
- ACON
- DCON
- SCON -CB
- SCON-CB (Servo press)
- SCON -LC
- SCON -CAL
- MSCON
- PSEL
- ASEL
- SSEL
- MSEL
- XSEL
- XSEL (SCARA)
- PSA-24
- TB-02
- TB-03

Procedure 8 Selection of a Fan Unit

When the controller operating environment could exceed 40°C, it is necessary to install a fan unit. (up to 55°C)
 The number of fan units is one half of the total number of the driver units.
 If the number of the driver units is an odd number, add 1 to the total odd number for the calculation purpose.
 When placing an order, specify the gateway unit model.

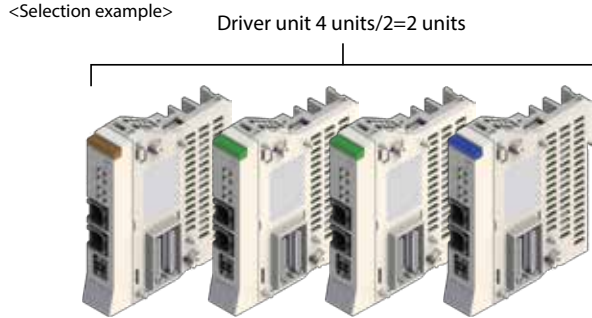

Even when a fan unit is installed, the ambient operating environment for the simple absolute unit is 0 to 40°C.

Procedure 9 Unit Model to Order

Please specify each unit model number for ordering.

- <Selection example>
- Gateway unit (with 2 fan units) [RCON-GW-CC-FU2] 1 6
 - Extension unit [RCON-EXT] 4
 - Driver unit [RCON-DC-1] 2
 - Driver unit [RCON-PC-2] 2
 - Driver unit [RCON-PC-1] 2
 - Driver unit [RCON-AC-2] 2
 - Simple Absolute unit [RCON-ABU-A] x 2 units 3
 - RCON connection specification SCON [SCON-*.***-RC] x 2 units 5

RCON

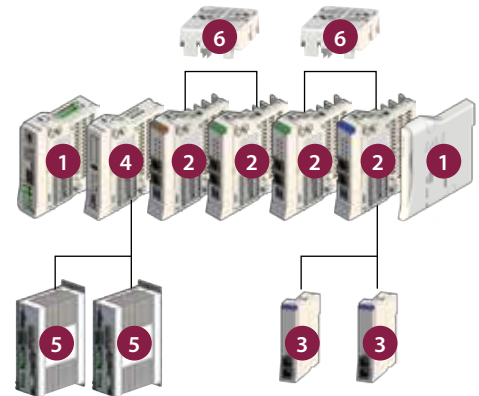

Model Specification Items

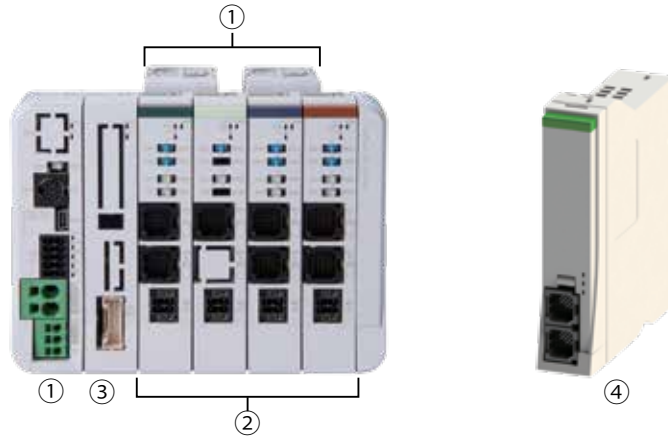

① Gateway unit

RCON - [] - [] - []

Series Type I/O Option

GW	Standard type	DV	DeviceNet connection specification	FU <input type="checkbox"/>	Fan unit installed (<input type="checkbox"/> :specify the number of units, 1 to 8)
GWG	Safety category compliant type	CC	CC-Link connection specification	TRN	Without terminal unit
		CIE	CC-Link IE Field connection specification	* A terminal unit is definitely necessary for operation.	
		PR	PROFIBUS-DP connection specification		
		EC	EtherCAT connection specification		
		EP	EtherNet/IP connection specification		
		PRT	PROFINET IO connection specification		

② Driver Unit

RCON - [] - []

Series Type Number of axes

PC	Stepper motor	1	1-axis specification
PCF	High-thrust stepper motor	2	2-axis specification
AC	AC servo motor		
DC	DC brushless motor		

Type: PC 1.2A motor 1 axis 2 axes	20P	20 <input type="checkbox"/> stepper motor
	20SP	20 <input type="checkbox"/> stepper motor (for RA2AC/RA2BC)
	28P	28 <input type="checkbox"/> stepper motor
	35P	35 <input type="checkbox"/> stepper motor
	42P	42 <input type="checkbox"/> stepper motor
	42SP	42 <input type="checkbox"/> stepper motor (for RCP4-RA5C)
Type: PCF 4A motor 1 axis	56P	56 <input type="checkbox"/> stepper motor
	56SP	56 <input type="checkbox"/> High-thrust stepper motor
	60P	60 <input type="checkbox"/> High-thrust stepper motor
	86P	86 <input type="checkbox"/> High-thrust stepper motor

* Type: Only one axis is selectable for PCF

Type: AC 2-30W motor 1 axis 2 axes	2	2W servo motor
	5	5W servo motor
	10	10W servo motor
	20	20W servo motor
	20S	20W servo motor (for RCA2-SA4/RCA-RA3)
	30	30W servo motor

Type: DC 3D motor 1 axis 2 axes	3D	2.5W DC brushless motor
--	----	-------------------------

③ Extension Unit

RCON - EXT

Series Extension

④ Simple Absolute Unit

RCON - ABU - [] - []

Series Absolute unit Type

P	Stepper motor
A	AC servo motor

⑤ SCON Controller (for connecting RCON)

SCON - [] - [] - [] - [] - RC - 0 - []

Type Motor Encoder Option I/O I/O cable length Power voltage

Please refer to SCON (P7-143) for model selection items.

System Configuration

Controller

Option

PC dedicated teaching software
(See P7-65)

<Model: IA-OS>
<Model: RCM-101-MW/USB>



for IA-OS: USB cable
for RCM-101:
Supplied with the PC dedicat-
ed teaching software

Option

24V Power supply
(See P7-66)
<Model: PSA-24(L)>



Option

Touch panel teaching pendant
(See P7-65)

<Model: TB-03> <Model: TB-02>



Supplied with GWG Specification

Dummy plug
(See P7-66)
<Model: DP-5>



Field network

DeviceNet, CC-Link,
CC-Link IE Field, EtherCAT,
EtherNet/IP,
PROFIBUS-DP, PROFINET IO

Supplied with gateway
unit

System I/O connector
(See P7-66)

<Model: DFMC 15.5-ST-3.5>



Option

Fan unit
(See P7-66)
<Model: RCON-FU>

RCON



Supplied with Simple Absolute Unit
Connection cable
(See P7-68)
<Model: CB-ADPC-MPA005>



Option

Simple absolute unit
(See P7-60)
<Model: RCON-ABU-P
(for stepper motor)>
<Model: RCON-ABU-A
(for AC servo motor)>

Supplied with SCON-CB
(RC specification)

Connection cable
(See P7-70)
<Model: CB-RE-CTL002>



Supplied with Driver unit

Drive power shutoff connector
(See P7-66)
<Model: DFMC1.5/2-STF-3.5>



Supplied with extension unit

Terminal connector
(See P7-66)
<Model: RCON-EXT-TR>



RCON connection
specification
SCON controller
[IO: RC]
(See General Catalog)

Motor-Encoder Cable *

Connectable actuators

RCS2/3/4 series
DDA series
LSA series
IS(D)B series
SSPA series

Please refer to P7-60 for the actuators that are not connectable.

PCP2/3/4/5/6 series

RCA/2 series

RCD series

* The motor - encoder cable is supplied with the actuator.
The motor - encoder cable varies depending on the connected actuator.
When ordering maintenance cables, please refer to P7-67.

Unit Configuration

The RCON has a unit-linkage construction. Please link the units according to the conditions described below.

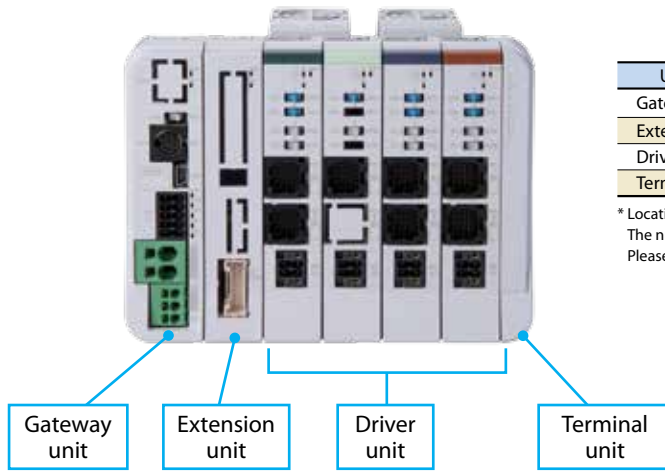

Unit name	Number of connected units	Location
Gateway unit	1	Left end
Extension unit	1	Right side, next to gateway unit
Driver unit	Max. 16 axes*	Left side, next to terminal unit
Terminal unit	1	Right end

* Locations are exchangeable within the driver unit.
 The number of maximum connectable axes varies depending on the operation mode.
 Please refer to the "Number of maximum connectable axes" on P7-61 for details.

Unit name and List of single unit model numbers

Product name		Model number	Reference page
Gateway unit (GWG: Safety category type)	DeviceNet connection specification	RCON-GW/GWG-DV	P7-55
	CC-Link connection specification	RCON-GW/GWG-CC	P7-55
	CC-Link IE Field connection specification	RCON-GW/GWG-CIE	P7-56
	PROFIBUS-DP connection specification	RCON-GW/GWG-PR	P7-56
	EtherCAT connection specification	RCON-GW/GWG-EC	P7-57
	EtherNet /IP connection specification	RCON-GW/GWG-EP	P7-57
	PROFINET IO connection specification	RCON-GW/GWG-PRT	P7-58
Extension unit	SCON-CB connection	RCON-EXT	P7-60
	Terminal connector (for SCON-CB)	RCON-EXT-TR	P7-66
Driver unit	Stepper motor, 1-axis specification	RCON-PC-1	P7-59
	Stepper motor, 2-axis specification	RCON-PC-2	
	High-thrust stepper motor, 1-axis specification	RCON-PCF-1	
	AC servo motor, 1-axis specification	RCON-AC-1	
	AC servo motor, 2-axis specification	RCON-AC-2	
	DC brush-less motor, 1-axis specification	RCON-DC-1	
Terminal unit	DC brush-less motor, 2-axis specification	RCON-DC-2	P7-60
	Supplied with gateway unit	RCON-GW-TR	
Simple absolute unit (1-axis specification)	For RCON-PC	RCON-ABU-P	P7-60
	For RCON-AC	RCON-ABU-A	
Fan unit	One unit for 2 driver units	RCON-FU	P7-66

Controller

EC

RCP6S

RCON

MCON
-C/LC

PCON
-CB/CFB

PCON

ACON-CB
DCON-CB

ACON
DCON

SCON
-CB

SCON-CB
(Servo press)

SCON
-LC

SCON
-CAL

MSCON

PSEL

ASEL

SSEL

MSEL

XSEL

XSEL
(SCARA)

PSA-24

TB-02

TB-03

Basic Specifications

Item	Specification			
Power voltage	24VDC±10%			
Power current	Varies depending on the system configuration. (See P7-54)			
Number of controlled axes	1-16 axes * Refer to the "Number of the maximum connectable axes" on P7-61 for the maximum axes.			
Encoder resolution [pulse/r]	Stepper motor	Incremental	800	
		Battery-less absolute	RCP4/RCP5	800
			RCP6	8192
	AC servo motor	Incremental	RCA	800
		Battery-less absolute		16384
		Incremental	RCA2-***N/NA	1048
	RCA2-***N/NAN以外		800	
	DC brush-less motor	Incremental	RCD-RA1R/GRSN	400
RCD-RA1DA/GRSNA			480	
Compatible field network	DeviceNet, CC-Link, CC-Link IE Field, PROFIBUS-DP, EtherCAT, EtherNet/IP, PROFINET IO			
Configured units	Gateway unit, Driver unit, Extension unit, Simple absolute unit (See P7-55)			
SIO Interface	Teaching port	Communication method	RS485	
		Communication speed	9.6/19.2/38.4/57.6/115.2/230.4kbps	
	USB port	Communication method	USB	
		Communication speed	12Mbps	
Emergency stop/Enable operation	The whole system reacts to the STOP signal of the gateway unit. Equipped with a connector that can shut off power supply of each axis by individual driver unit.			
Data storage device	Storing the position data and parameters in the involatile memory (no limit on the number of writing)			
Calendar function	Data retention function: approx. 10 days, Energizing time: approx. 100 hours			
Safety category compliance	B (The safety category compliance specification conforms with up to Class 4 by using an external circuit.)			
Protection function	Over current, Abnormal temperature, Encoder disconnection, Overload			
Preventive & predictive maintenance function	Low capacity of electrolytic condenser, Low fan rotational speed			
Operating ambient temperature	0-55°C * 0-40°C for simple absolute unit			
Operating ambient humidity	85%RH or less. No condensing			
Operating ambient atmosphere	No corrosive gases, no significant dust			
Vibration resistance	Vibration frequency 10 to 57Hz/amplitude: 0.075mm, Vibration frequency 57 to 150Hz/acceleration 9.8m/S ² XYZ directions each Sweepage time: 10 minutes Number of sweepages: 10 times			
Shock resistance	Drop height 800mm, 1 corner, 3 edges, 6 surfaces			
Electric shock protection mechanism	Class III			
Degree of protection	IP20			
Dielectric strength voltage	DC500V, 10MΩ			
Calorific value (per unit)	RCN-PC	Power CON: No	5.0W	
		Power CON: Yes	8.0W	
	RCN-PCF	Power CON: No	19.2W	
	RCN-AC	Standard/High-acceleration-deceleration/Energy-saving	4.5W	
	RCN-DC	Standard	3.0W	
Cooling method	Natural cooling, (optional) Forced cooling by fan unit			
Linkage between units	Unit-linkage method			
Installation method	Mounted on DIN rail (35mm)			
Standard	CE marking, UL certificate, RoHS			

Power supply capacity

Please make a selection after confirming that as a result of the calculation of the control power and motor power for each unit based on the connection configuration, the calculated current does not exceed the current limit.

Item	Current limit value
Control power	9.0A or smaller
Motor power	37.5A or smaller

Power supply capacity by unit

Item	Specification						
Power voltage	24VDC±10%						
Control power capacity (per unit)	Gateway unit (including terminal unit)				0.8A		
	Driver unit (common in all types)	Brake: No				0.2A	
		Brake: Yes (1 axis)				0.4A	
		Brake: Yes (2 axes)				0.6A	
	Extension unit				0.1A		
Simple absolute unit (common in all types)				0.2A			
Motor power capacity (per one axis of actuator)	Actuator/driver unit				Rated current	Max. current	
		Series	Motor type			Energy-saving enabled	
	Stepper motor /RCON-PC	RCP2	20P/20SP/28P	without Power CON	0.8A	—	—
		RCP3	28P*		1.9A	—	—
		RCP4	28P/35P/42P/42SP/56P	without Power CON	1.9A	—	—
		RCP5 RCP6		with Power CON	2.3A	—	3.9A
	Stepper motor /RCON-PCF	RCP2 RCP4 RCP5 RCP6	56SP/60P/86P	without Power CON	5.7A	—	—
	AC servo motor /RCON-AC	RCA RCA2	5W	Standard/ High acceleration-deceleration	1.0A	—	3.3A
			10W		1.3A	2.5A	4.4A
			20W	Standard/ High acceleration-deceleration/ Energy-saving	1.3A	2.5A	4.4A
			20W (20S)		1.7A	3.4A	5.1A
			30W		1.3A	2.2A	4.0A
		RCL	2W	Standard/ High acceleration-deceleration	0.8A	—	4.6A
			5W		1.0A	—	6.4A
			10W		1.3A	—	6.4A
DC brush-less motor /RCON-DC		RCD	3W	Standard	0.7A	—	1.5A

* Compatible models: RCP2-RA3 and RCP2-RGD3

System Configuration

Controller

Gateway Unit

- Features Unit to be connected to field networks.
(GWG specification is a safety category compliant type.)

Gateway unit DeviceNet connection specification



Network connector

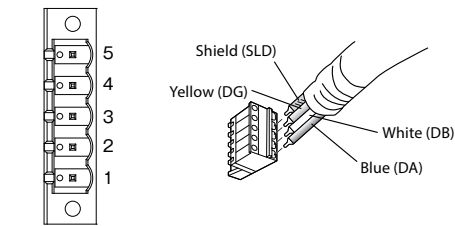

Controller side connector top view

Specifications

Model RCON-GW/GWG-DV

Power supply	24VDC±10%
Control power	0.8A
Operating ambient temperature/humidity	0-55°C, 85%RH or less, non-condensing
Operating atmosphere	No corrosive gases, no significant dust
Degree of protection	IP20
Weight	154g
External dimensions	W30mm x H115mm x D95mm

Connector		Connector (make)	Remarks
System I/O	Cable side	DFMC1.5/5-ST-3.5	Supplied standard item
Network	Cable side	MSTB2.5/5-STF-5.08 AUM (Phoenix Contact)	Supplied standard item
	Controller side	MSTBA2.5/5-GF-5.08 AU (Phoenix Contact)	

Network connection cable

Pin NO.	Signal name (color)	Description	Adoptable wire diameter
1	V- (black)	Power cable - side	DeviceNet dedicated cable
2	CAN L (blue)	Communication data Low side	
3	—	Drain (shield)	
4	CAN H (white)	Communication data High side	
5	V+ (red)	Power cable + side	

Gateway Unit CC-Link connection specification



Network connector

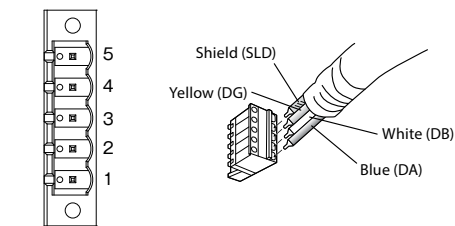

Controller side connector top view

Specifications

Model RCON-GW/GWG-CC

Power supply	24VDC±10%
Control power	0.8A
Operating ambient temperature/humidity	0-55°C, 85%RH or less, non-condensing
Operating atmosphere	No corrosive gases, no significant dust
Degree of protection	IP20
Weight	154g
External dimensions	W30mm x H115mm x D95mm

Connector		Connector (make)	Remarks
System I/O	Cable side	DFMC1.5/5-ST-3.5	Supplied standard item
Network	Cable side	MSTB2.5/5-STF-5.08 AU (Phoenix Contact) With terminal resistor 10Ω/130Ω	Supplied standard item
	Controller side	MSTB2.5/5-GF-5.08 AU (Phoenix Contact)	

Network connection cable

Pin NO.	Signal name (color)	Description	Adoptable wire diameter
1	DA (blue)	Communication line A	CC-Link dedicated cable
2	DB (white)	Communication line B	
3	DG (yellow)	Digital ground	
4	SLD	Connect shield of shield cable (Connect the 5 pin FG and the control power connector 1 pin FG internally.)	
5	FG	Frame ground (Connect the 4 pin SLD and the control power connector 1 pin FG internally.)	

System Configuration

Controller

Gateway Unit CC-Link IE Field connection specification



Network connector

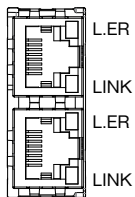

Controller side connector top view

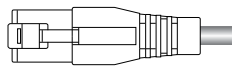

Specifications

Model RCON-GW/GWG-CIE

Power supply	24VDC±10%
Control power	0.8A
Operating ambient temperature/humidity	0-55°C, 85%RH or less, non-condensing
Operating atmosphere	No corrosive gases, no significant dust
Degree of protection	IP20
Weight	165g
External dimensions	W30mm x H115mm x D95mm

Connector	Connector (make)	Remarks
System I/O	Cable side DFMC1.5/5-ST-3.5	Supplied standard item
Network	Cable side Ethernet ANSI/TIA/EIA-568-B Category 5e or higher with shield 8P8C modular plug (RJ45)	Customer's supply
	Controller side Ethernet ANSI/TIA/EIA-568-B Category 5e or higher with shield 8P8C modular plug (RJ45)	

Network connection cable

Pin NO.	Signal name (color)	Description	Adoptable wire diameter
1	TP0 +	Data 0 +	Use an Ethernet cable of Category 5e or higher, straight STP cable.
2	TP0 -	Data 0 -	
3	TP1 +	Data 1 +	
4	TP2 +	Data 2 +	
5	TP2 -	Data 2 -	
6	TP1 -	Data 1 -	
7	TP3 +	Data 3 +	
8	TP3 -	Data 3 -	

Gateway Unit PROFIBUS-DP connection specification



Network connector

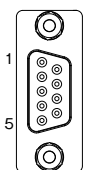

Controller side connector top view

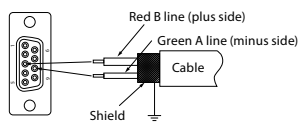

Specifications

Model RCON-GW/GWG-PR

Power supply	24VDC±10%
Control power	0.8A
Operating ambient temperature/humidity	0-55°C, 85%RH or less, non-condensing
Operating atmosphere	No corrosive gases, no significant dust
Degree of protection	IP20
Weight	158g
External dimensions	W30mm x H115mm x D95mm

Connector	Connector (make)	Remarks
System I/O	Cable side DFMC1.5/5-ST-3.5	Supplied standard item
Network	Cable side 9pin D-sub connector (male)	Customer's supply
	Controller side 9pin D-sub connector (female)	

Network connection cable

Pin NO.	Signal name (color)	Description	Adoptable wire diameter
1	NC	Not connected	PROFIBUS-DP dedicated cable (type A: EN5017)
2	NC	Not connected	
3	B-Line	Communication line B (RS485)	
4	RTS	Transmission request	
5	GND	Signal GND (isolated)	
6	+5V	+5V output (isolated)	
7	NC	Not connected	
8	A-Line	Communication line A (RS485)	
9	NC	Not connected	

- EC
- RCP6S
- RCON
- MCON -C/LC
- PCON -CB/CFB
- PCON
- ACON-CB
- DCON-CB
- ACON DCON
- SCON -CB
- SCON-CB (Servo press)
- SCON -LC
- SCON -CAL
- MSCON
- PSEL
- ASEL
- SSEL
- MSEL
- XSEL
- XSEL (SCARA)
- PSA-24
- TB-02
- TB-03

System Configuration

Controller

Gateway Unit EtherCAT Connection Specification



Network connector

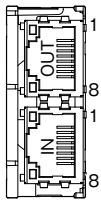

Controller side connector top view

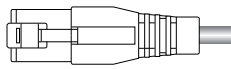

Specifications

Model RCON-GW/GWG-EC

Power supply	24VDC±10%
Control power	0.8A
Operating ambient temperature/humidity	0-55°C, 85%RH or less, non-condensing
Operating atmosphere	No corrosive gases, no significant dust
Degree of protection	IP20
Weight	152g
External dimensions	W30mm x H115mm x D95mm

Connector	Connector (make)	Remarks
System I/O	Cable side DFMC1.5/5-ST-3.5	Supplied standard item
Network	Cable side Ethernet ANSI/TIA/EIA-568-B Category 5 or higher 8P8C modular plug with shield (RJ45)	Customer's supply
	Controller side Ethernet ANSI/TIA/EIA-568-B Category 5 or higher 8P8C modular plug with shield (RJ45)	

Network connection cable

Pin NO.	Signal name (color)	Description	Adoptable wire diameter
1	TD +	Transmission data +	Use an Ethernet cable of Category 5 or higher, straight STP cable
2	TD -	Transmission data -	
3	RD +	Receiving data +	
4	-	Not used	
5	-	Not used	
6	RD -	Receiving data -	
7	-	Not used	
8	-	Not used	

Gateway Unit EtherNet/IP Connection Specification



Network connector



Controller side connector top view

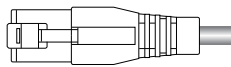

Specifications

Model RCON-GW/GWG-EP

Power supply	24VDC±10%
Control power	0.8A
Operating ambient temperature/humidity	0-55°C, 85%RH or less, non-condensing
Operating atmosphere	No corrosive gases, no significant dust
Degree of protection	IP20
Weight	156g
External dimensions	W30mm x H115mm x D95mm

Connector	Connector (make)	Remarks
System I/O	Cable side DFMC1.5/5-ST-3.5	Supplied standard item
Network	Cable side Ethernet ANSI/TIA/EIA-568-B Category 5 or higher 8P8C modular plug with shield (RJ45)	Customer's supply
	Controller side Ethernet ANSI/TIA/EIA-568-B Category 5 or higher 8P8C modular plug with shield (RJ45)	

Network connection cable

Pin NO.	Signal name (color)	Description	Adoptable wire diameter
1	TD +	Transmission data +	Use an Ethernet cable of Category 5 or higher, straight STP cable.
2	TD -	Transmission data -	
3	RD +	Receiving data +	
4	-	Not used	
5	-	Not used	
6	RD -	Receiving data -	
7	-	Not used	
8	-	Not used	

Gateway Unit PROFINET IO connection specification



Network connector



Controller side connector top view

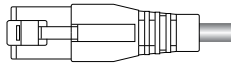

Specifications

Model RCON-GW/GWG-PRT

Power supply	24VDC±10%
Control power	0.8A
Operating ambient temperature/humidity	0-55°C, 85%RH or less, non-condensing
Operating atmosphere	No corrosive gases, no significant dust
Degree of protection	IP20
Weight	158g
External dimensions	W30mm x H115mm x D95mm

Connector		Connector (make)	Remarks
System I/O	Cable side	DFMC1.5/5-ST-3.5	Supplied standard item
Network	Cable side	Ethernet ANSI/TIA/EIA-568-B Category 5 or higher 8P8C modular plug with shield (RJ45)	Customer's supply
	Controller side	Ethernet ANSI/TIA/EIA-568-B Category 5 or higher 8P8C modular plug with shield (RJ45)	

Network connection cable

Pin NO.	Signal name (color)	Description	Adoptable wire diameter
1	TD +	Transmission data +	Use an Ethernet cable of Category 5 or higher, straight STP cable.
2	TD -	Transmission data -	
3	RD +	Receiving data +	
4	-	Not used	
5	-	Not used	
6	RD -	Receiving data -	
7	-	Not used	
8	-	Not used	

- EC
- RCP6S
- RCON
- MCON -C/LC
- PCON -CB/CFB
- PCON
- ACON-CB
- DCON-CB
- ACON DCON
- SCON -CB
- SCON-CB (Servo press)
- SCON -LC
- SCON -CAL
- MSCON
- PSEL
- ASEL
- SSEL
- MSEL
- XSEL
- XSEL (SCARA)
- PSA-24
- TB-02
- TB-03

System Configuration

Controller

Driver Unit

- **Features** Controller unit to control actuators.
One unit can be connected up to 2 axes.

Driver Unit for connecting RCP series

Driver unit for connecting stepper motors.
All the RCP series actuators can be connected.



Model	Type	Compatible motor capacity
RCON-PC-1	1 axis connection	1.2A (□ 20/28/35/42/56)
RCON-PC-2	2 axes connection	
RCON-PCF-1	1 axis connection * for high-thrust	4A (□ 56/60/86)

Specifaions

Power supply	24VDC±10%
Control power	(without brake) 0.2A (with brake, 1-axis) 0.4A (with brake, 2-axis) 0.6A
Operating ambient temperature/humidity	(without fan) 0-40°C (with fan) 0-55°C, 85%RH or less, non-condensing
Operating atmosphere	No corrosive gases, no significant dust
Degree of protection	IP20
Weight	(1 axis) 175g (2 axes) 180g
External dimensions	W22.6mm x H115mm x D95mm
Accessories	Drive power cutoff connector (DFMC1.5/2-STF-3.5)

Driver Unit for connecting RCA series

Driver unit for connecting AC servo motors.
All the RCA series actuators can be connected.



Model	Type	Compatible motor capacity
RCON-AC-1	1 axis connection	2W - 30W
RCON-AC-2	2 axes connection	

Specifaions

Power supply	24VDC±10%
Control power	(without brake) 0.2A (with brake, 1-axis) 0.4A (with brake, 2-axis) 0.6A
Operating ambient temperature/humidity	(without fan) 0-40°C (with fan) 0-55°C, 85%RH or less, non-condensing
Operating atmosphere	No corrosive gases, no significant dust
Degree of protection	IP20
Weight	(1 axis) 175g (2 axes) 180g
External dimensions	W22.6mm x H115mm x D95mm
Accessories	Drive power cutoff connector (DFMC1.5/2-STF-3.5)

Driver Unit for connecting RCD series

Driver unit for connecting DC brush-less motors.
All the RCD series actuators can be connected.



Model	Type	Compatible motor capacity
RCON-DC-1	1 axis connection	3W
RCON-DC-2	2 axes connection	

Specifaions

Power supply	24VDC±10%
Control power	(without brake) 0.2A (with brake, 1-axis) 0.4A (with brake, 2-axis) 0.6A
Operating ambient temperature/humidity	(without fan) 0-40°C (with fan) 0-55°C, 85%RH or less, non-condensing
Operating atmosphere	No corrosive gases, no significant dust
Degree of protection	IP20
Weight	(1 axis) 175g (2 axes) 180g
External dimensions	W22.6mm x H115mm x D95mm
Accessories	Drive power cutoff connector (DFMC1.5/2-STF-3.5)

EC

RCP6S

RCON

MCON
-C/LC

PCON
-CB/CFB

PCON

ACON-CB
DCON-CB

ACON
DCON

SCON
-CB

SCON-CB
(Servo press)

SCON
-LC

SCON
-CAL

MSCON

PSEL

ASEL

SSEL

MSEL

XSEL

XSEL
(SCARA)

PSA-24

TB-02

TB-03

Other Units

Extension Unit

Possible to operate actuators with 200V motors by means of connecting SCON-CB/CGB.



Model
RCON-EXT

Specifications

Power supply	24VDC±10%
Control power	0.1A
Operating ambient temperature/humidity	0-55°C, 85%RH or less, non-condensing
Operating atmosphere	No corrosive gases, no significant dust
Degree of protection	IP20
Weight	96g
External dimensions	W22.6mm × H115mm × D95mm
Accessory	Terminal connector

Actuators that cannot be connected

Servo press type, ISA-W21, SCARA robots, TTA, ZR unit, Wrist units

Terminal Unit

An end point of serial communication of RCON and a terminal resistor of the input/output signals.
(It comes with the gateway unit as a standard supplied item.)



Model
RCON-GW-TR

Price is for a single unit.
The price is included in the gateway unit ordered, unless an option "TRN" is selected.

Specifications

Power supply	24VDC±10%
Control power	0.8A
Operating ambient temperature/humidity	0-55°C, 85%RH or less, non-condensing
Operating atmosphere	No corrosive gases, no significant dust
Degree of protection	IP20
Weight	48g
External dimensions	W12.6mm × H115mm × D95mm

Simple Absolute Unit

This unit is connected when an incremental actuator is used as an absolute specification.



Model	Type	Compatible motor capacity
RCON-ABU-P	for RCP series	Stepper motor
RCON-ABU-A	for RCA series	AC servo motor

Specifications

Power supply	24VDC±10%
Control power	0.2A
Absolute battery model	AB-7
Battery voltage	3.6V
Charging time	Approx. 72 hours
Operating ambient temperature/humidity	0-40°C, 85%RH or less, non-condensing
Operating atmosphere	No corrosive gases, no significant dust
Degree of protection	IP20
Weight	271g (including 173g of absolute battery)
External dimensions	W22.6mm×H115mm×D95mm
Accessory	Cable (CB-ADPC-MPA005)

Field network operation mode

In the field network control operation mode, an operation is performed by one of the following control modes. The operation is performed by writing the necessary data (target position, speed, acceleration, push current value, etc.) from the host PLC device into the predetermined address.

Operation mode	Description	Overview
Direct numerical control mode	The target position, speed, acceleration/deceleration and push current limit values can be specified. In addition to the current position in 0.01mm units, the current speed and current command value can be monitored.	
Simple direct numerical value mode	Target positions can be specified directly in numeric values. The current position can be monitored in 0.01mm units.	
Positioner 1 mode	The position data can be registered up to 128 points and pauses can be made at the registered positions. The current position can be monitored in 0.01mm units.	
Positioner 2 mode	The position data can be registered up to 128 points and pauses can be made at the registered positions. The current position can not be monitored. This mode contains subset data that has been eliminated transmit/receive data from the positioner 1 mode.	
Positioner 3 mode	The position data can be registered up to 128 points and pauses can be made at the registered positions. The current position can not be monitored. This mode contains subset data that has been eliminated transmit/receive data from the positioner 2 mode, and controls using the minimum signals required for motions.	
Positioner 5 mode	The position data can be registered up to 16 points and pauses can be made at the registered positions. The current position can not be monitored. This mode contains a subset data that has been eliminated transmit/receive data and position table from the positioner 2 mode, and the current positions can be monitored in 0.1mm units.	

Number of Maximum Connectable Axes

Operation mode	Direct numerical control mode	Simple direct numerical mode	Positioner 1 mode	Positioner 2 mode	Positioner 3 mode	Positioner 5 mode
Field network						
DeviceNet	8 axes	16 axes	16 axes	16 axes	16 axes	16 axes
CC-Link	16 axes	16 axes	16 axes	16 axes	16 axes	16 axes
CC-Link IE Field	16 axes	16 axes	16 axes	16 axes	16 axes	16 axes
PROFIBUS-DP	8 axes	16 axes	16 axes	16 axes	16 axes	16 axes
EtherCAT	8 axes	16 axes	16 axes	16 axes	16 axes	16 axes
EtherNet/IP	8 axes	16 axes	16 axes	16 axes	16 axes	16 axes
PROFINET IO	8 axes	16 axes	16 axes	16 axes	16 axes	16 axes

List of Functions by Operation Mode

	Direct numerical control mode	Simple direct numerical mode	Positioner 1 mode	Positioner 2 mode	Positioner 3 mode	Positioner 5 mode
Number of positioning points	No limit	128 points	128 points	128 points	128 points	16 points
Home return operation	○	○	○	○	○	○
Positioning operation	○	○	△	△	△	△
Setting of velocity and acceleration/ deceleration	○	△	△	△	△	△
Different setting of acceleration and deceleration	×	△	△	△	△	△
Pitch feeding (incremental)	○	△	△	△	×	△
JOG operation	△	△	△	△	×	△
Writing position data	×	×	○	○	×	×
Push-motion operation	○	△	△	△	△	△
Speed change while travelling	○	△	△	△	△	△
Pause	○	○	○	○	○	○
Zone signal output	△ (2 points)	△ (2 points)	△ (2 points)	△ (2 points)	△ (1 point)	△ (2 points)
Position zone signal output	×	△	△	△	×	×
Overload alarm output	○	○	○	○	×	○
Damping control (Note 1)	×	△	△	△	△	△
Read current value (Note 2) (Resolution)	○ (0.01mm)	○ (0.01mm)	○ (0.01mm)	×	×	○(Note 3) (0.01mm)

*○: Direct setting possible, △: Position data or parameter input is needed, ×: Operation not possible.

(Note 1) Function limited to AC servo motor specification.

(Note 2) When a SCON controller is used to control a DDA motor, the resolution is 0.001 degrees (0.01 degrees in positioner 5 mode).

(Note 3) The maximum output value in the positioner 5 mode is 3,276.7mm (327.67 degrees for DDA motor).

When controlling the actuator in an operation range exceeding the maximum value, please use another operation mode.

Controller

EC

RCP6S

RCON

MCON

-C/LC

PCON

-CB/CFB

PCON

ACON-CB

DCON-CB

ACON

DCON

SCON

-CB

SCON-CB

(Servo press)

SCON

-LC

SCON

-CAL

MSCON

PSEL

ASEL

SSEL

MSEL

XSEL

XSEL

(SCARA)

PSA-24

TB-02

TB-03

External Dimensions

Gateway unit

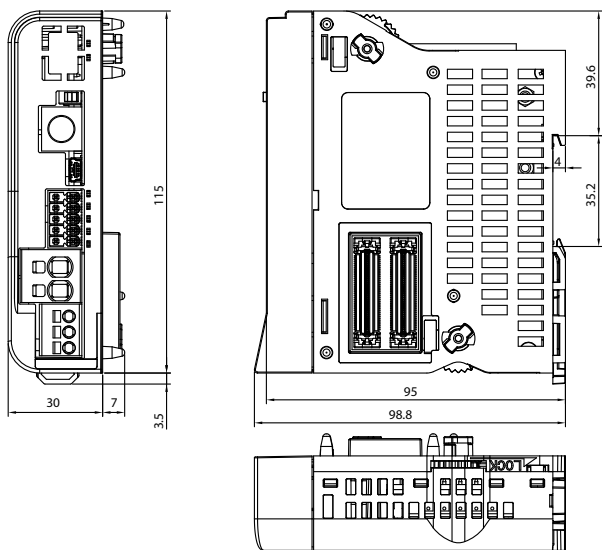

Terminal unit

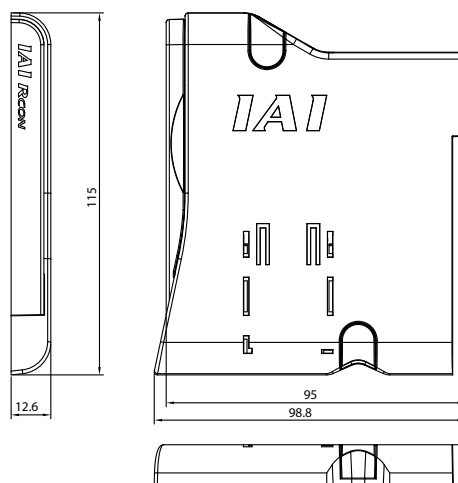

Driver unit

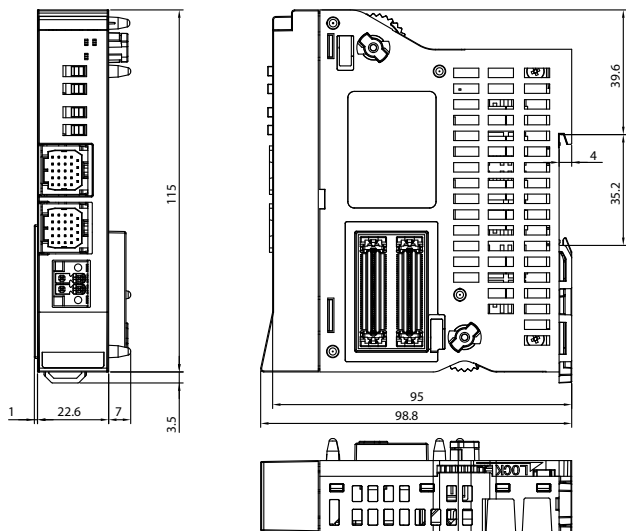

Extension unit

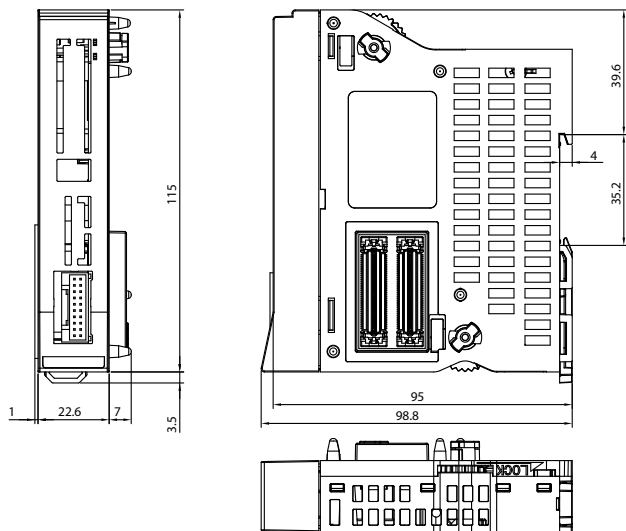

Simple absolute unit

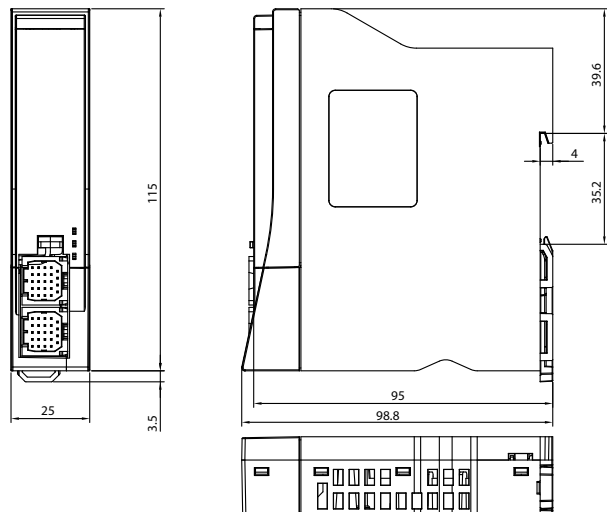

Fan unit

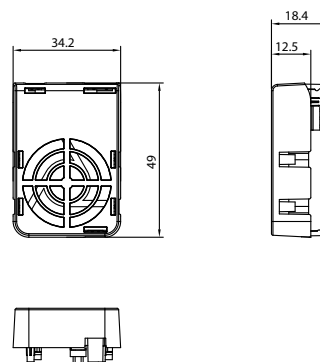

Controller

EC

RCP6S

RCON

MCON
-C/LC

PCON
-CB/CFB

PCON

ACON-CB
DCON-CB

ACON
DCON

SCON
-CB

SCON-CB
(Servo press)

SCON
-LC

SCON
-CAL

MSCON

PSEL

ASEL

SSEL

MSEL

XSEL

XSEL
(SCARA)

PSA-24

TB-02

TB-03

Examples of Combined Units

Four Driver units without fan

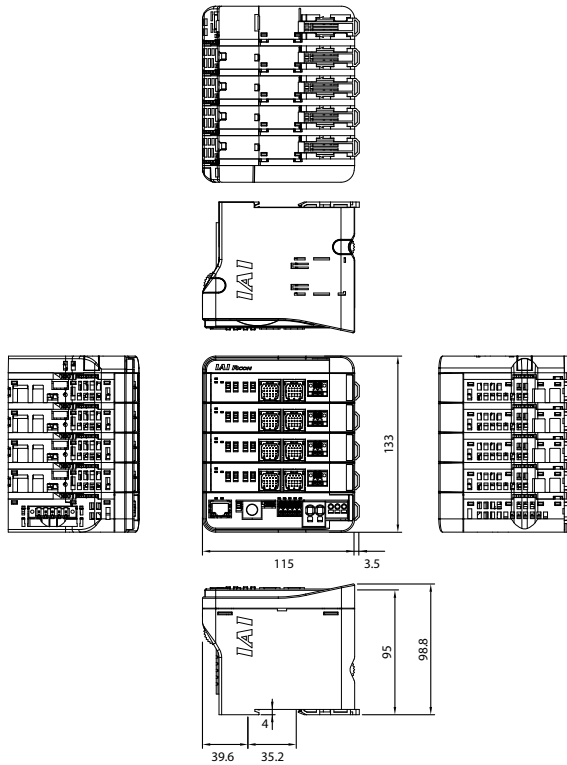

Four Driver units with fan

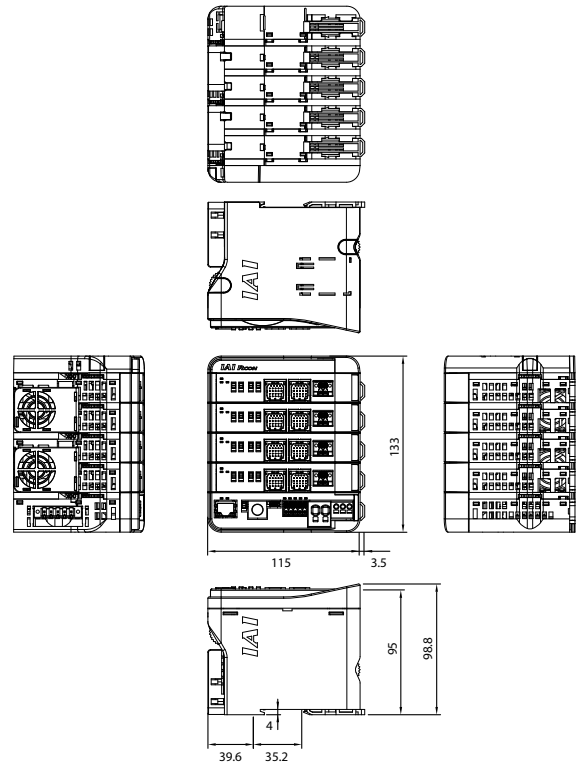

Eight driver units without fan

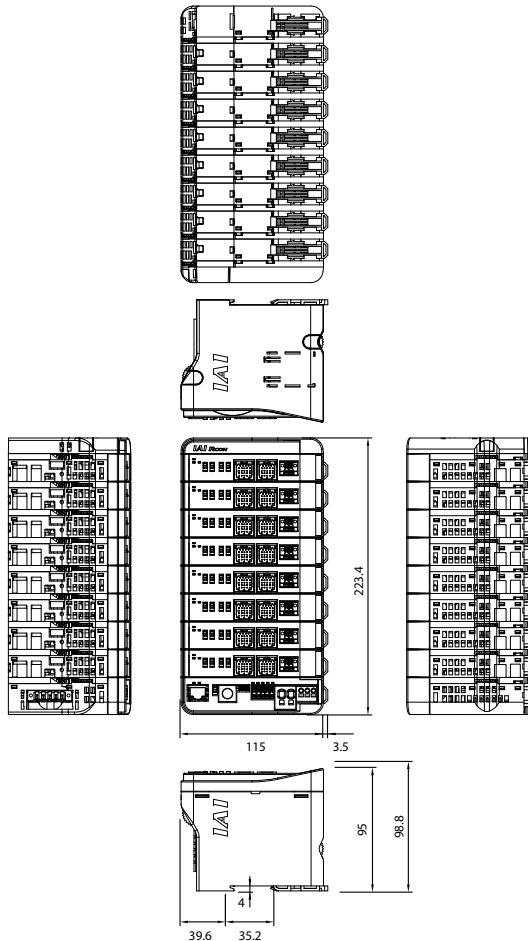

Eight driver units with fan

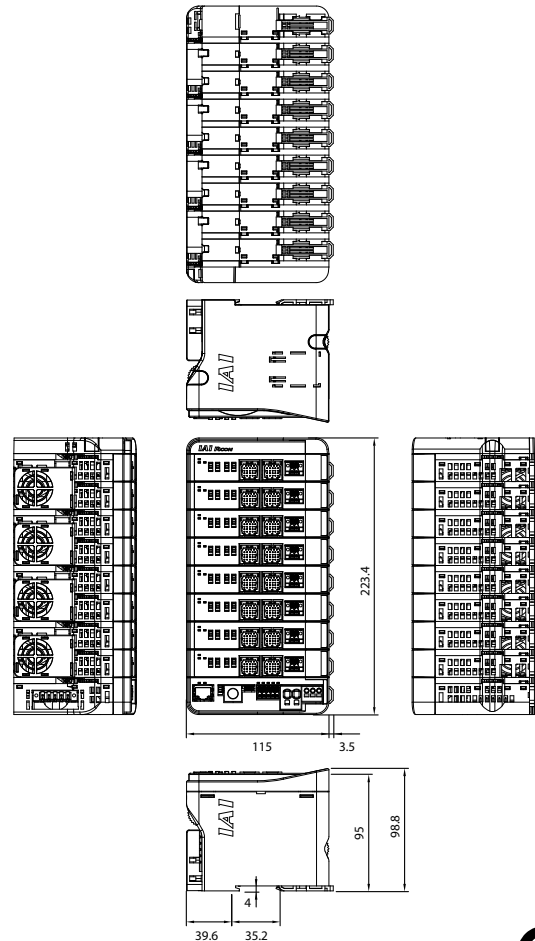

Controller

EC

RCP6S

RCON

MCON

-C/LC

PCON

-CB/CFB

PCON

ACON-CB

DCON-CB

ACON

DCON

SCON

-CB

SCON-CB

(Servo press)

SCON

-LC

SCON

-CAL

MSCON

PSEL

ASEL

SSEL

MSEL

XSEL

XSEL

(SCARA)

PSA-24

TB-02

TB-03

Option

Controller

EC

RCP6S

RCON

MCON

PCON

PCON

ACON-CB

DCON-CB

ACON

DCON

SCON

-CB

SCON-CB

(Servo press)

SCON

-LC

SCON

-CAL

MSCON

PSEL

ASEL

SSEL

MSEL

XSEL

(SCARA)

PSA-24

TB-02

TB-03

Touch Panel Teaching Pendant

Features Teaching device with functions such as position input, trial run and monitoring.

Model **TB-03**-□ Please visit IAI website for compatible versions.

Configuration

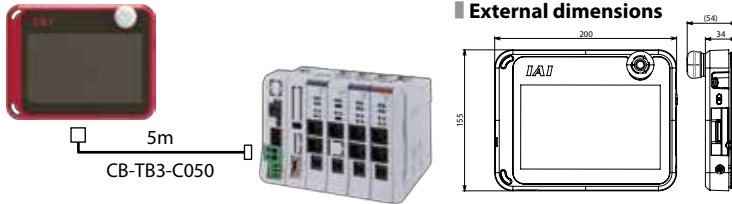

Specification

Rated voltage	24VDC
Power consumption	3.6W or smaller (150mA or smaller)
Ambient operational temperature	0 to 40°C
Ambient operational humidity	20 to 85% RH (non-condensing)
Protection class	IPX0
Weight	670g (in case of TB-03 main unit only)
Charging method	Dedicated AC adapter / Wired connection with controller
Wireless connection	Bluetooth 4.2 Class 2

Model **TB-02(D)**-□ Please visit IAI website for compatible versions.

Configuration



Specification

Rated voltage	24VDC
Power consumption	3.6W or smaller (150mA or smaller)
Ambient operational temperature	0 to 40°C
Ambient operational humidity	20 to 85% RH (non-condensing)
Protection class	IP20
Weight	470g (in case of TB-02 main unit only)

PC dedicated Teaching Software (Windows only)

Features Startup supporting software for position input, trial run and monitoring, etc. Reduces the startup time by substantial supporting functions necessary for adjustments.

Model **IA-OS**

Configuration Please visit IAI website for compatible versions.

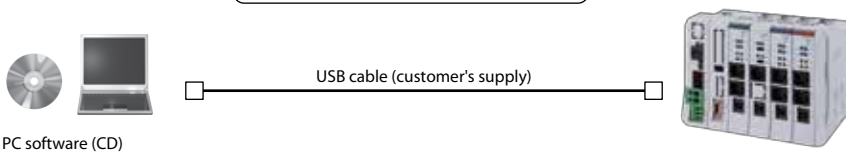

Model **RCM-101-MW** (with external device communication cable + RS232 conversion unit)

Configuration Please visit IAI website for compatible versions.

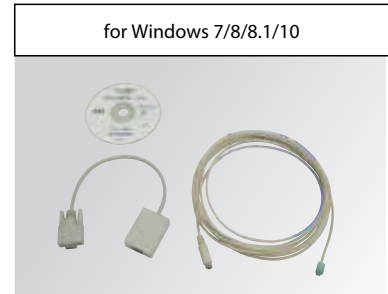
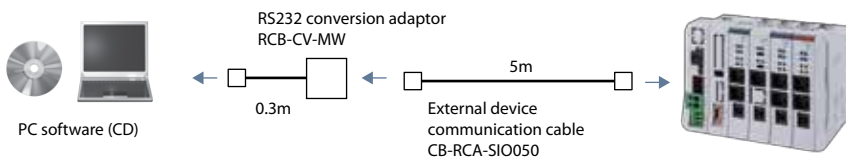

Model **RCM-101-USB** (With external device communication cable + USB conversion adaptor + USB cable)

Configuration Please visit IAI website for compatible versions.

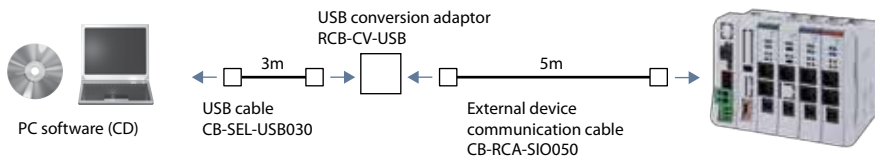

24V Power Supply

Overview Power supply unit that has the same height as the RCON's and that can be installed easily.
It can also monitor the status of power supply by connecting the RCON.

Model PSA-24 (without fan)

Model PSA-24L (with fan)



Specification Table

Model	Specification	
	AC100V input	AC200V input
Input power voltage range	AC100V - AC230V±10%	
Input power current	3.9A or smaller	1.9A or smaller
Power supply capacity RCON-PC-2	without fan: 250VA	without fan: 280VA
	with fan: 390VA	with fan: 380VA
Rush current *1	without fan: 17A (typ) with fan: 27.4A (typ)	without fan: 34A (typ) with fan: 54.8A (typ)
Caloric value	28.6W	20.4W
Output voltage range *2	24V±10%	
Continuous rated output	Without fan: 8.5A (204W), with fan: 13.8A (330W)	
Peak output	17A (408W)	
Efficiency	86% or higher	90% or higher
Parallel linkage *3	Max. 5 units	

*1 The pulse duration of the rush current is 5ms or smaller.
*2 To enable parallel operations, this power supply unit can change output voltage according to load. For this reason, this power supply unit is dedicated to IAI controllers.
*3 Parallel connections under the following conditions are not possible.
* Parallel connections of PSA-24 (without fan specification) and PSA-24L (with fan specification).
* Parallel connections with the power supply units other than this unit.
* Parallel connection with PS-24.

External dimensions

PSA-24

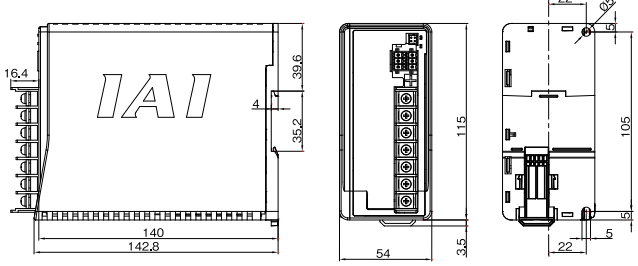

PSA-24L

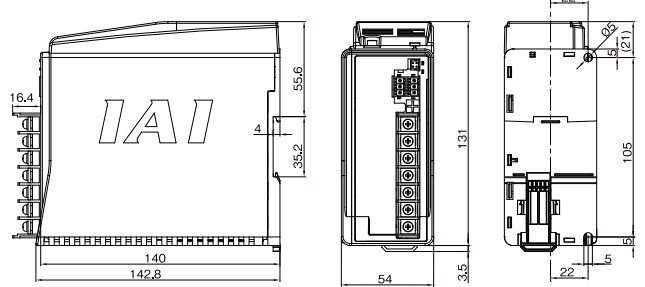

Maintenance Parts

Fan Unit

Overview Option to forced-cool the driver unit. One fan unit is necessary for 2 driver units.

Model RCON-FU



Dummy Plug

Overview Necessary for safety category compliant specification (GWG).

Model DP-5



System I/O Connector

Overview Connector for emergency stop input and external input to change operation mode, etc.

Model DFMC1.5/5-ST-3.5



Drive Power Cutoff Connector

Overview Connector for input of the drive power cutoff

Model DFMC1.5/2-STF-3.5



Terminal Connector

Overview Necessary as a terminal resistor when connecting SCON.

Model RCON-EXT-TR



Replacement Battery

Overview Replacement battery for simple absolute unit.

Model AB-7



- EC
- RCP6S
- RCON
- MCON -C/LC
- PCON -CB/CFB
- PCON
- ACON-CB
DCON-CB
- ACON
DCON
- SCON -CB
- SCON-CB (Servo press)
- SCON -LC
- SCON -CAL
- MSCON
- PSEL
- ASEL
- SSEL
- MSEL
- XSEL
- XSEL (SCARA)
- PSA-24
- TB-02
- TB-03

Maintenance Parts (Cables)

When ordering maintenance cables after the purchase of the product, please refer to the following model numbers.

Table of Cables

No.	Actuator		Applicable controller model number	RCON connecting cable (Note 2) (-RB: Robot cable) [Connecting cable for actuators]	Conversion unit	Wiring diagram
	Series	Applicable type				
①	RCP6 RCP6CR RCP6W	Other than high-thrust type (Note 1)	P5	CB-ADPC-MPA□□□(-RB)	—	A
②	RCP5 RCP5CR RCP5W	High-thrust type (Note 1)	P6	CB-ADPC-MPA□□□(-RB) CB-CAN-AJ002 (Conversion cable)	—	B
③		Gripper (GR*), ST4525E, SA3/RA3	P5	CB-ADPC-MPA□□□(-RB)	—	A
④	RCP4 RCP4CR RCP4W	High-thrust type (Note 1)	P6	CB-ADPC-MPA□□□(-RB) CB-CAN-AJ002 (Conversion cable)	—	B
⑤		Other than (3) and (4)	P5	CB-ADPC-MPA□□□(-RB) CB-CAN-AJ002 (Conversion cable)	—	B
⑥	RCP3		P5	CB-RCAPC-MPA□□□(-RB)	—	C
⑦		RCP2 Rotary small type of RCP2 (Standard type) RCP2-RTBS/RTBSL/RTCS/RTCSL	P5	CB-ADPC-MPA□□□(-RB) [CB-RPSEP-MPA□□□]	Necessary	D
⑧		RCP2CR (Clean type), RCP2W (dust & splash proof type) Rotary (RT*) of the above types GRS/GRM/GR3SS/GR3SM of the above types	P5	CB-ADPC-MPA□□□(-RB)	—	A
⑨	RCP2 RCP2CR RCP2W	All types (standard/clean/dust- & splash-proof) of GRSS/GRLS/GRST/GRHM/GRHB. Overall length short type (only RCP2) RCP2-SRA4R/SRGS4R/SRGD4R	P5	CB-RCAPC-MPA□□□(-RB)	—	C
⑩		High-thrust type (Note 1)	P6	CB-ADPC-MPA□□□(-RB) [CB-CFA-MPA□□□-RB]	Necessary	D
⑪		Other than (7) - (10)	P5	CB-ADPC-MPA□□□(-RB) [CB-PSEP-MPA□□□]	Necessary	D
⑫	RCA2/RCA2CR/RCA2W, RCL		A6	CB-RCAPC-MPA□□□(-RB)	—	C
⑬	RCA2/RCA2CR/RCA2W (CNS option)		A6	CB-ADPC-MPA□□□(-RB)	—	A
⑭	RCA RCACR RCAW	Overall length short type (RCA only) RCA-SRA4R/SRGS4R/SRGD4R	A6	CB-RCAPC-MPA□□□(-RB)	—	C
⑮		Other than (14)	A6	CB-ADPC-MPA□□□(-RB) [CB-ASEP2-MPA□□□]	Necessary	D
⑯	RCD	RCD-RA1DA, RCD-GRSNA	D6	CB-ADPC-MPA□□□(-RB)	—	A

Note 1: Actuators using high-thrust stepper motors (565P, 60P and 86P).

Note 2: The length between each driver unit and the actuator is up to 20m, with or without a conversion unit.
However, the maximum length between the D driver unit and the RCD actuator is up to 10m.

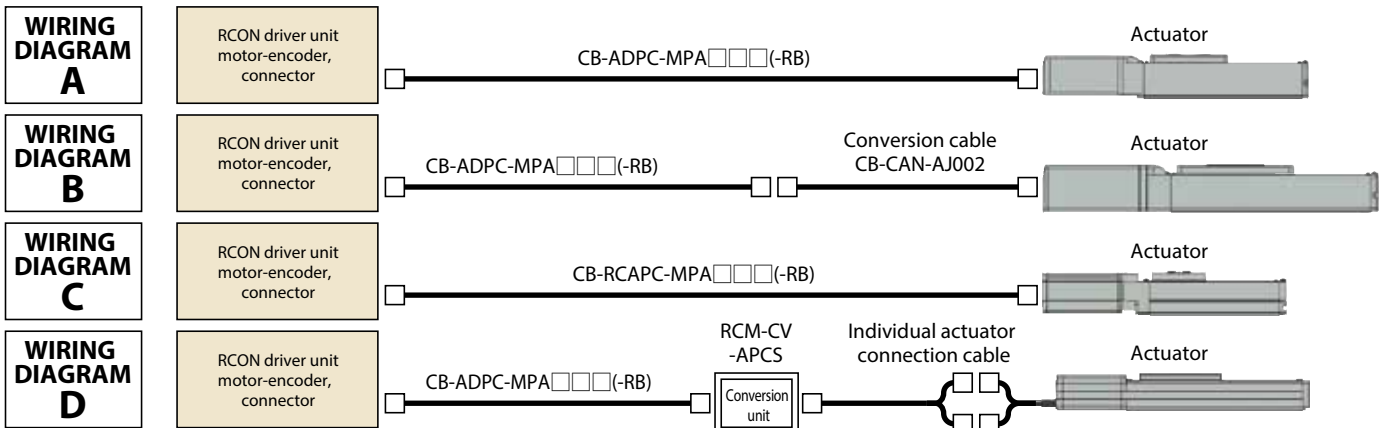

Model **CB-ADPC-MPA** / **CB-ADPC-MPA** -**RB**

*Specify the cable length (L) in □□□, Maximum 20m. Ex) 030=3m.

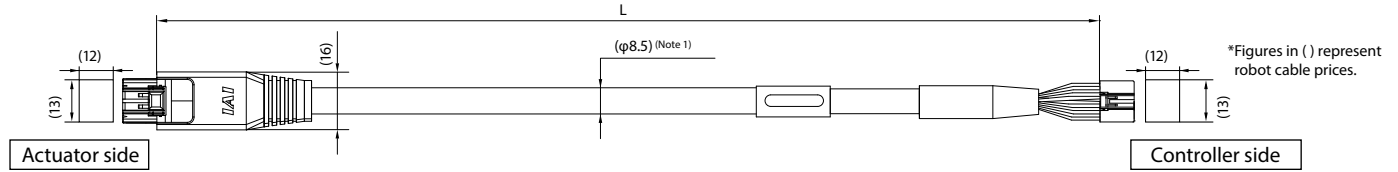

Minimum bending radius R 5m or less, r=68mm or more (Dynamic bending condition)
 More than 5m, r=73mm or more (Dynamic bending condition)

* The robot cable is for flex-resistance. Please use a robot cable when a cable bear is installed inside.

(Note 1) When the cable length is 5m or longer, its diameter is φ9.1.

DF62DL-245-2.2C (Hirose)					DF62DL-245-2.2C (Hirose)				
Color	Signal name			Pin No.	Pin No.	Signal name			Color
	DC	AC	PC			PC	AC	DC	
Blue(AWG22/19)	U	U	φA	3	3	φA	U	U	Blue(AWG22/19)
Orange(AWG22/19)	V	V	VMM	5	5	VMM	V	V	Orange(AWG22/19)
Brown(AWG22/19)	-	-	φB	10	10	φB	-	-	Brown(AWG22/19)
Grey(AWG22/19)	-	-	VMM	9	9	VMM	-	-	Grey(AWG22/19)
Green(AWG22/19)	W	W	φ_A	4	4	φ_A	W	W	Green(AWG22/19)
Red(AWG22/19)	-	-	φ_B	15	15	φ_B	-	-	Red(AWG22/19)
Light blue(AWG26)	A+	A+	SA[mABS]	12	12	SA[mABS]	A+	A+	Light blue(AWG26)
Orange(AWG26)	A-	A-	SB[mABS]	17	17	SB[mABS]	A-	A-	Orange(AWG26)
Green(AWG26)	B+	B+	A+	1	1	A+	B+	B+	Green(AWG26)
Brown(AWG26)	B-	B-	A-	6	6	A-	B-	B-	Brown(AWG26)
Grey(AWG26)	HS1_IN	Z+/SA[mABS]	B+	11	11	B+	Z+/SA[mABS]	HS1_IN	Grey(AWG26)
Red(AWG26)	HS2_IN	Z-/SB[mABS]	B-	16	16	B-	Z-/SB[mABS]	HS2_IN	Red(AWG26)
Black(AWG26)	-	VPS/BAT-	VPS	18	18	VPS	VPS/BAT-	-	Black(AWG26)
Yellow(AWG26)	-	BK+	LS+	8	8	LS+	BK+	-	Yellow(AWG26)
Light blue(AWG26)	-	LS+	BK+	20	20	BK+	LS+	-	Light blue(AWG26)
Orange(AWG26)	-	LS-	BK-	2	2	BK-	LS-	-	Orange(AWG26)
Grey(AWG26)	VCC	VCC	VCC	21	21	VCC	VCC	VCC	Grey(AWG26)
Red(AWG26)	GND	GND	GND	7	7	GND	GND	GND	Red(AWG26)
Brown(AWG26)	-	BK-	LS-	14	14	LS-	BK-	-	Brown(AWG26)
Green(AWG26)	HS3_IN	LS_GND	LS_GND	13	13	LS_GND	LS_GND	HS3_IN	Green(AWG26)
-	-	-	-	19	19	-	-	-	-
Pink(AWG26)	-	BAT+	CF_VCC	22	22	CF_VCC	BAT+	-	Pink(AWG26)
-	-	-	-	23	23	-	-	-	-
Black(AWG26)	FG	FG	FG	24	24	FG	FG	FG	Black(AWG26)

Model **CB-RCAPC-MPA** / **CB-RCAPC-MPA** -**RB**

*Specify the cable length (L) in □□□, Maximum 20m. Ex) 030=3m.

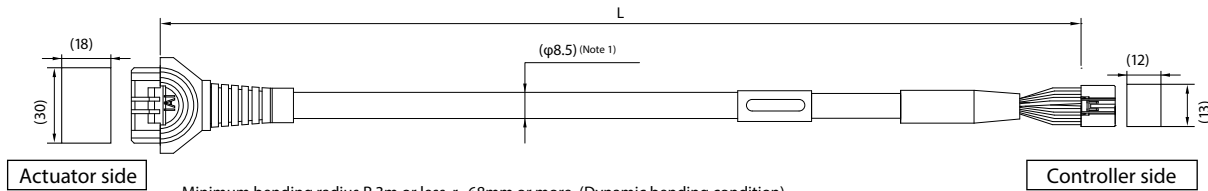

Minimum bending radius R 3m or less, r=68mm or more (Dynamic bending condition)
 More than 3m, r=73mm or more (Dynamic bending condition)

* The robot cable is for flex-resistance. Please use a robot cable when a cable bear is installed inside.

(Note 1) When the cable length is 3m or longer, its diameter is φ9.1.

1-1827863-1(AMP)					DF62DL-245-2.2C (Hirose)				
Color	Signal name			Pin No.	Pin No.	Signal name			Color
	DC	AC	PC			PC	AC	DC	
Blue(AWG22/19)	U	U	φA	A1	3	φA	U	U	Blue(AWG22/19)
Orange(AWG22/19)	V	V	VMM	B1	5	VMM	V	V	Orange(AWG22/19)
Brown(AWG22/19)	-	-	φB	B2	10	φB	-	-	Brown(AWG22/19)
Grey(AWG22/19)	-	-	VMM	A3	9	VMM	-	-	Grey(AWG22/19)
Green(AWG22/19)	W	W	φ_A	A2	4	φ_A	W	W	Green(AWG22/19)
Red(AWG22/19)	-	-	φ_B	B3	15	φ_B	-	-	Red(AWG22/19)
Light blue(AWG26)	A+	A+	SA[mABS]	A6	12	SA[mABS]	A+	A+	Light blue(AWG26)
Orange(AWG26)	A-	A-	SB[mABS]	B6	17	SB[mABS]	A-	A-	Orange(AWG26)
Green(AWG26)	B+	B+	A+	A7	1	A+	B+	B+	Green(AWG26)
Brown(AWG26)	B-	B-	A-	B7	6	A-	B-	B-	Brown(AWG26)
Grey(AWG26)	HS1_IN	Z+/SA[mABS]	B+	A8	11	B+	Z+/SA[mABS]	HS1_IN	Grey(AWG26)
Red(AWG26)	HS2_IN	Z-/SB[mABS]	B-	B8	16	B-	Z-/SB[mABS]	HS2_IN	Red(AWG26)
Black(AWG26)	-	VPS/BAT-	VPS	B9	18	VPS	VPS/BAT-	-	Black(AWG26)
Yellow(AWG26)	-	BK+	LS+	A4	8	LS+	BK+	-	Yellow(AWG26)
Light blue(AWG26)	-	LS+	BK+	A5	20	BK+	LS+	-	Light blue(AWG26)
Orange(AWG26)	-	LS-	BK-	B5	2	BK-	LS-	-	Orange(AWG26)
Grey(AWG26)	VCC	VCC	VCC	A10	21	VCC	VCC	VCC	Grey(AWG26)
Red(AWG26)	GND	GND	GND	B10	7	GND	GND	GND	Red(AWG26)
Brown(AWG26)	-	BK-	LS-	B4	14	LS-	BK-	-	Brown(AWG26)
Green(AWG26)	HS3_IN	LS_GND	LS_GND	A9	13	LS_GND	LS_GND	HS3_IN	Green(AWG26)
-	-	-	-	A11	19	-	-	-	-
-	-	-	-	-	22	CF_VCC	BAT+	-	Grey(AWG26)
-	-	-	-	-	23	-	-	-	-
Black(AWG26)	FG	FG	FG	B11	24	FG	FG	FG	Black(AWG26)

Model CB-RPSEP-MPA * Robot cable is the standard.

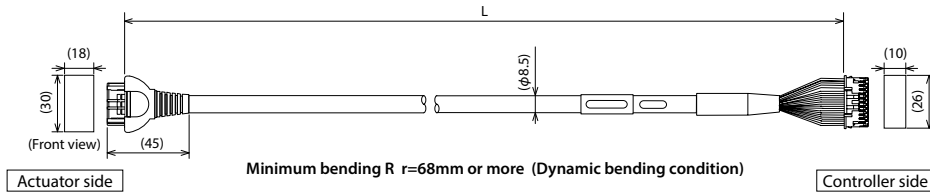

Actuator side
D-1100D 1-1827863-1
(AMP)

Terminal No.	Signal name
A1	Black (ΦA)
B1	White (VMM)
A2	Brown (Φ/A)
B2	Green (ΦB)
A3	Yellow (VMM)
B3	Red (Φ/B)
A6	Orange (LS+)
B6	Grey (LS-)
A7	Red (A+)
B7	Green (A-)
A8	Black (B+)
B8	Brown (B-)
A4	NC
B4	NC
A5	Black (id tape) [BK+]
B5	Brown (id tape) [BK-]
A9	Green (id tape) [GNDLS]
B9	Red (id tape) [VPS]
A10	White (id tape) [VCC]
B10	Yellow (id tape) [GND]
A11	NC
B11	Shield (FG) [FG]
	NC
	NC

Controller side
PADP-24V-1-S
(JST)

Terminal No.	Signal name
1	Black (ΦA)
2	White (VMM)
3	Brown (Φ/A)
4	Green (ΦB)
5	Yellow (VMM)
6	Red (Φ/B)
7	Orange (LS+)
8	Grey (LS-)
9	Red (A+)
13	Green (A-)
14	Black (B+)
15	Brown (B-)
16	NC
17	Black (id tape) [BK+]
18	Brown (id tape) [BK-]
19	Green (id tape) [GNDLS]
20	Red (id tape) [VPS]
21	White (id tape) [VCC]
22	Yellow (id tape) [GND]
23	NC
24	Shield (FG) [FG]
	NC
	NC

*Specify the cable length (L) in
Maximum 20m. Ex) 080=8m.

Model CB-CFA-MPA /CB-CFA-MPA -RB * Robot cable is the standard.

(Note 1) When the cable length is 3m or longer, non-robot cable diameter is Φ9.1 and robot cable diameter is Φ10.

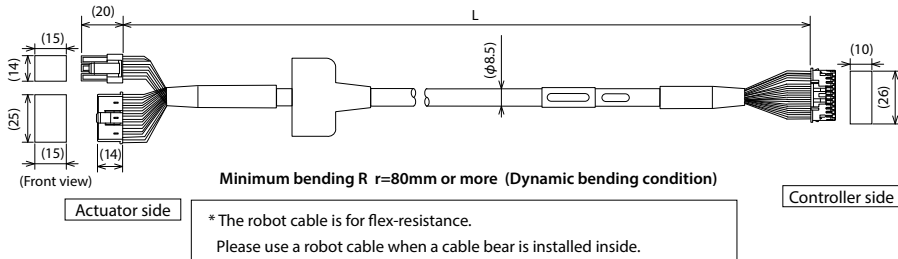

Actuator side
SLP-06V(JST)
XMP-18V(JST)

Pin No.	Signal name
1	φA
2	VMM
4	φB
5	VMM
3	φ/A
6	φ/B
5	NC
6	NC
13	LS+
14	LS-
1	A+
2	A-
3	B+
4	B-
16	BK+
17	BK-
12	VCC
9	GND
11	VPS
10	NC
18	FG
15	NC
7	NC
8	NC

Controller side
PADP-24V-1-S
(JST)

Pin No.	Signal name
1	φA
2	VMM
3	φB
4	VMM
5	φ/A
6	φ/B
11	NC
12	NC
7	LS+
8	LS-
13	A+
14	A-
15	B+
16	B-
9	BK+
10	BK-
21	VCC
19	GND
18	VPS
20	NC
24	FG
17	NC
22	NC
23	NC

*Specify the cable length (L) in
Maximum 20m. Ex) 080=8m.

Model CB-PSEP-MPA * Robot cable is the standard.

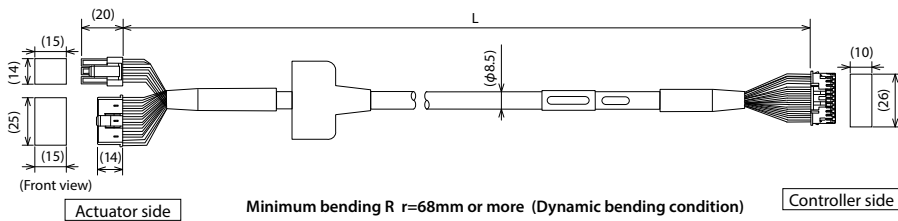

Actuator side
SLP-06V(JST)
XMP-18V(JST)

Terminal No.	Signal name
1	Black (ΦA)
2	White (VMM)
4	Red (ΦB)
5	Green (VMM)
3	Brown (Φ/A)
6	Yellow (Φ/B)
16	Orange (BK+)
17	Grey (BK-)
6	NC
6	NC
13	Black (LS+)
14	Brown (LS-)
1	White (A+)
2	Yellow (A-)
4	Red (B+)
3	Green (B-)
10	White (id tape) [VCC]
11	Yellow (id tape) [VPS]
9	Red (id tape) [GND]
12	Green (id tape) [spare]
15	NC
7	NC
8	NC
18	Shield (FG)

Controller side
PADP-24V-1-S
(JST)

Terminal No.	Signal name
1	Black (ΦA)
2	White (VMM)
3	Red (ΦB)
4	Green (VMM)
5	Brown (Φ/A)
6	Yellow (Φ/B)
9	Orange (BK+)
10	Grey (BK-)
11	NC
12	NC
7	Black (LS+)
8	Brown (LS-)
13	White (A+)
14	Yellow (A-)
15	Red (B+)
16	Green (B-)
17	White (id tape) [VCC]
18	Yellow (id tape) [VPS]
19	Red (id tape) [GND]
20	Green (id tape) [spare]
21	NC
22	NC
23	NC
24	Shield (FG)

*Specify the cable length (L) in
Maximum 20m. Ex) 080=8m.

Model CB-ASEP2-MPA * Robot cable is the standard.

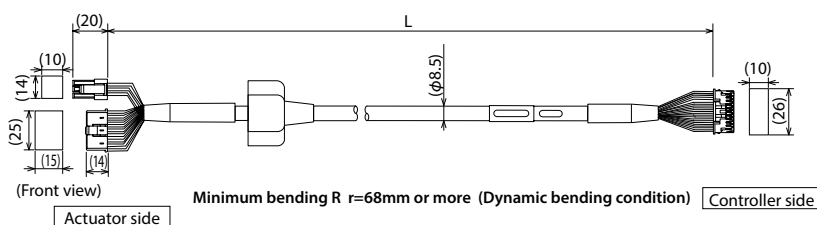

Actuator side
SLP-06V(JST)
XMP-18V(JST)

Terminal No.	Signal name
1	Red (U)
2	Yellow (V)
	NC
	NC
3	Black (W)
	NC
18	Orange (BK+)
17	Grey (BK-)
7	Black (LS+)
16	Brown (LS-)
1	White (A+)
2	Yellow (A-)
3	Red (B+)
4	Green (B-)
10	Black (id tape) [Z+]
11	Brown (id tape) [Z-]
14	White (id tape) [VCC]
15	Yellow (id tape) [GND]
13	Red (id tape) [VPS/BAT-]
6	Green (id tape) [spare]
12	White (BAT+)
5	NC
8	NC
9	Shield (FG)

Controller side
PADP-24V-1-S
(JST)

Terminal No.	Signal name
1	Red (U)
2	Yellow (V)
3	NC
4	NC
5	Black (W)
6	NC
7	Orange (BK+)
8	Grey (BK-)
9	Black (LS+)
10	Brown (LS-)
11	White (A+)
12	Yellow (A-)
13	Red (B+)
14	Green (B-)
15	Black (id tape) [Z+]
16	Brown (id tape) [Z-]
17	White (id tape) [VCC]
18	Yellow (id tape) [GND]
19	Red (id tape) [VPS/BAT-]
20	Green (id tape) [spare]
21	White (BAT+)
22	NC
23	NC
24	Shield (FG)

*Specify the cable length (L) in
Maximum 20m. Ex) 080=8m.

Model **CB-CAN-AJ002**

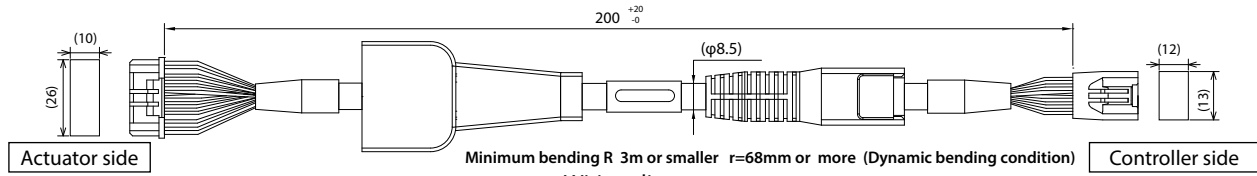

Wiring diagram

1-1827863-1 (AMP)					DF62B-24EP-2.2C (Hirose)				
Pin No.	Signal name			Color	Pin No.	Signal name			Color
	PC	AC	DC			PC	AC	DC	
A1	ΦA	U	U	Blue(AWG22)	3	ΦA	U	U	Blue(AWG22)
B1	VMM	V	V	Orange(AWG22)	5	VMM	V	V	Orange(AWG22)
B2	ΦB	-	-	Brown(AWG22)	10	ΦB	-	-	Brown(AWG22)
A3	VMM	-	-	Grey(AWG22)	9	VMM	-	-	Grey(AWG22)
A2	Φ A	W	W	Green(AWG22)	4	Φ A	W	W	Green(AWG22)
B3	Φ B	-	-	Red(AWG22)	15	Φ B	-	-	Red(AWG22)
A6	S _A (mABS)	A+	A+	Light blue(AWG26)	12	S _A (mABS)	A+	A+	Light blue(AWG26)
B6	S _B (mABS)	A-	A-	Orange(AWG26)	17	S _B (mABS)	A-	A-	Orange(AWG26)
A7	A+	B+	B+	Green(AWG26)	1	A+	B+	B+	Green(AWG26)
B7	A-	B-	B-	Brown(AWG26)	6	A-	B-	B-	Brown(AWG26)
A8	B+	Z ₊ (S _m ABS)	HS1_IN	Grey(AWG26)	11	B+	Z ₊ (S _m ABS)	HS1_IN	Grey(AWG26)
B8	B-	Z ₋ (S _m ABS)	HS2_IN	Red(AWG26)	16	B-	Z ₋ (S _m ABS)	HS2_IN	Red(AWG26)
B9	VPS	VPS/BAT-	-	Black(AWG26)	18	VPS	VPS/BAT-	-	Black(AWG26)
A4	LS+	BK+	-	Yellow(AWG26)	8	LS+	BK+	-	Yellow(AWG26)
A5	BK+	LS+	-	Light blue(AWG26)	20	BK+	LS+	-	Light blue(AWG26)
B5	BK-	LS-	-	Orange(AWG26)	2	BK-	LS-	-	Orange(AWG26)
A10	VCC	VCC	VCC	Grey(AWG26)	21	VCC	VCC	VCC	Grey(AWG26)
B10	GND	GND	GND	Red(AWG26)	7	GND	GND	GND	Red(AWG26)
B4	LS-	BK-	-	Brown(AWG26)	14	LS-	BK-	-	Brown(AWG26)
A9	LS_GND	LS_GND	HS3_IN	Green(AWG26)	13	LS_GND	LS_GND	HS3_IN	Green(AWG26)
A11	-	-	-	-	19	-	-	-	-
B11	FG	FG	FG	Black(AWG26)	22	CF_VCC	BAT+	-	Grey(AWG26)
					23	-	-	-	-
					24	FG	FG	FG	Black(AWG26)

Model **RCM-CV-APCS**

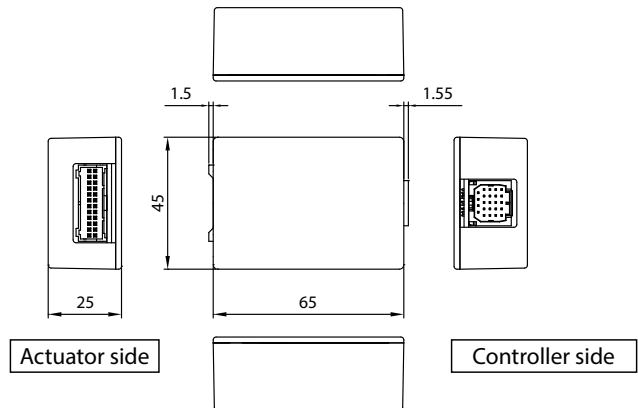

Model **CB-RE-CTL**

*Specify the cable length (L) in . Maximum 10m. Ex) 080=8m.

